

RECUPERATORI DI CALORE SERIE "RCA" / "RCA-V"

HEAT RECUPERATOR "RCA" / "RCA-V" SERIES

RECUPERADORES DE CALOR SERIE "RCA" / "RCA-V"

1

DESCRIZIONE GENERALE

IMPIEGO.

Questi recuperatori, la cui serie è costituita da 14 grandezze, sono adatti per il recupero di calore in ambienti pubblici come bar, sale riunioni, locali di piccola e media dimensione.

PRINCIPIO DI FUNZIONAMENTO.

All'interno del recuperatore i flussi d'aria uscente ed entrante si incrociano senza mischiarsi, mentre il calore dell'aria ambiente viziata viene trasferito all'aria esterna fredda di rinnovo.

Il rendimento del pacco di scambio in alluminio, in condizioni standard (esterno -5°C, interno 20°C con 50% di u.r.) risulta sempre superiore al 50%.

Il raccordo circolare con i canali di mandata e ripresa può essere montato indifferentemente su ogni lato del recuperatore in fase d'opera, per facilitare l'installazione per la serie RCA.

CARATTERISTICHE COSTRUTTIVE.

Involucro esterno in lamiera di acciaio zincato e preverniciato. Bacinella di raccolta condensa con scarico condensa. Isolante con materassino fonoassorbente posto sul pannello inferiore. Attacchi circolari di ingresso e uscita aria. Filtri piani o pieghettati a celle filtranti in fibra sintetica efficienza F6-F7-F8-F9 in base alle esigenze o richieste. Pacco di scambio in alluminio trattato, per consentire il recupero anche se parziale di calore latente.

Ventilatori a statore rotante con girante a pale rovesce (modello RCA e RCA-V 300-550-800-1000-1400) monofase, regolabile.

Ventilatore a pale avanti monofase regolabile, direttamente accoppiato (modello RCA e RCA-V 1800-2000-2600-3000-3500-4200).

Ventilatore a pale avanti trifase, direttamente accoppiato (modello RCA e RCA-V-TD 5500-6500-7000).

- Pacco di scambio norme EUROVENT



ACCESSORI.

Regolatore di tensione elettronico digitale a nove posizioni.

- Batterie elettriche serie BAT
- Batterie ad acqua calda/fredda da inserire a canale su richiesta.
- Su richiesta si possono fornire altri accessori.
- Controllo elettronico CO₂ filtri



RECUPERADORES DE CALOR SERIE "RCA" / "RCA-V"

HEAT RECUPERATOR "RCA" / "RCA-V" SERIES
RECUPERADORES DE CALOR SERIE "RCA" / "RCA-V"



Recuperator to
EUROVENT rules

Intercambiador de placas
norma EUROVENT

GB

GENERAL DESCRIPTION

USED.

These recuperators, constituted of 14 series, are used to regenerate heat in public rooms, like pub, meeting room, small and medium locals.

WORKING PRINCIPLES.

Inside hot air and outside cool air cross together but they don't mix and mean while the hot of the inside defected air is being transferd to outside cool air.

The efficiency of the recuperator in standard conditions (outside -5°C, inside 20°C with 50% of relative humidity) is always upper than 50%.

The circular connections with exhaust and supply ducts can be fixed on each different side of the recuperator, to make easier the installation, for the RCA series.

FEATURES.

Painted and galvanized sheet steel case. Condense discharge drop tank. Acoustic insultation fire-retardant lining on the lower cover panel. Pleated filters. Efficiency F6-F7-F8-F9 as needed or requested. Backward blades impeller centrifugal fans with outside rotor (type RCA and RCA-V 300-550-800-1000-1400) singlephase. Forward blades, singlephase, centrifugal fan, directly coupled (type RCA and RCA-V 1800-2000-2600-3000-3500-4200).

ACCESSORIES.

Electronic digital speed controller singlephase with 9 speed positions.

- Electric battery series BAT
- Cool or warm water battery to be included on request.
- Other accessories
- Electric control for CO₂ filters



E

DESCRIPCION GENERAL

EMPLEO

Estos recuperadores, cuya serie comprende 14 medidas, son adecuados para la recuperación de calor en ambientes públicos como bares, salones de reuniones y locales de pequeña y mediana dimensión.

PRINCIPIO DE FUNCIONAMIENTO

En el interior del recuperador, los flujos de aire saliente y entrante se cruzan sin mezclarse, mientras el calor del aire viciado del ambiente se transfiere al aire de renovación del exterior.

El rendimiento del intercambiador de aluminio, en condiciones normales (exterior -5°C, interior 20°C con 50% de humedad relativa) resulta siempre superior al 50%.

Los racores circulares para los conductos de impulsión y extracción, pueden montarse indiferentemente en cada uno de los lados del recuperador mientras éste se está instalando, para la serie RCA.

CARACTERISTICAS DE FABRICACIÓN

Mueble de chapa de acero cincado y prebarnizado. Bandeja de recogida de la condensación con sistema de desagüe. Aislante con colchoneta fonoabsorbente colocada en el panel inferior. Conexiones circulares de entrada y de salida del aire. Filtros planos y plegados con celdas filtrantes de fibra sintética con una eficacia de F6-F7-F8-F9. Recuperador de placas de aluminio construido para permitir la recuperación parcial, del calor latente. Ventiladores de rotor exterior con turbinas de palas curvadas hacia atrás monofásico, regulable (modelos RCA y RCA-V 300-550-800-1000-1400) ventilador con palas hacia delante monofásico regulable (modelos RCA y RCA-V 1800-2000-2600-3000-3500-4200).

Ventilador con palas hacia delante trifásico (modelos RCA y RCA-V-TD 5500-6500-7000).

ACCESORIOS

Regulador de tensión electrónico digital / analogico / Inverter

- Baterías eléctricas serie BAT
- Baterías de agua caliente/fría
- Módulos con filtros, Serie CFT

- Techo/tejadillo para intemperie
- Control electrónico para CO₂ y filtros.
- Sondas de CO₂, temperatura, humedad

SCHEDA DI FUNZIONAMENTO AERAUICO

AIR-FLOW SCHEDULE

FICHA TECNICA

RCA

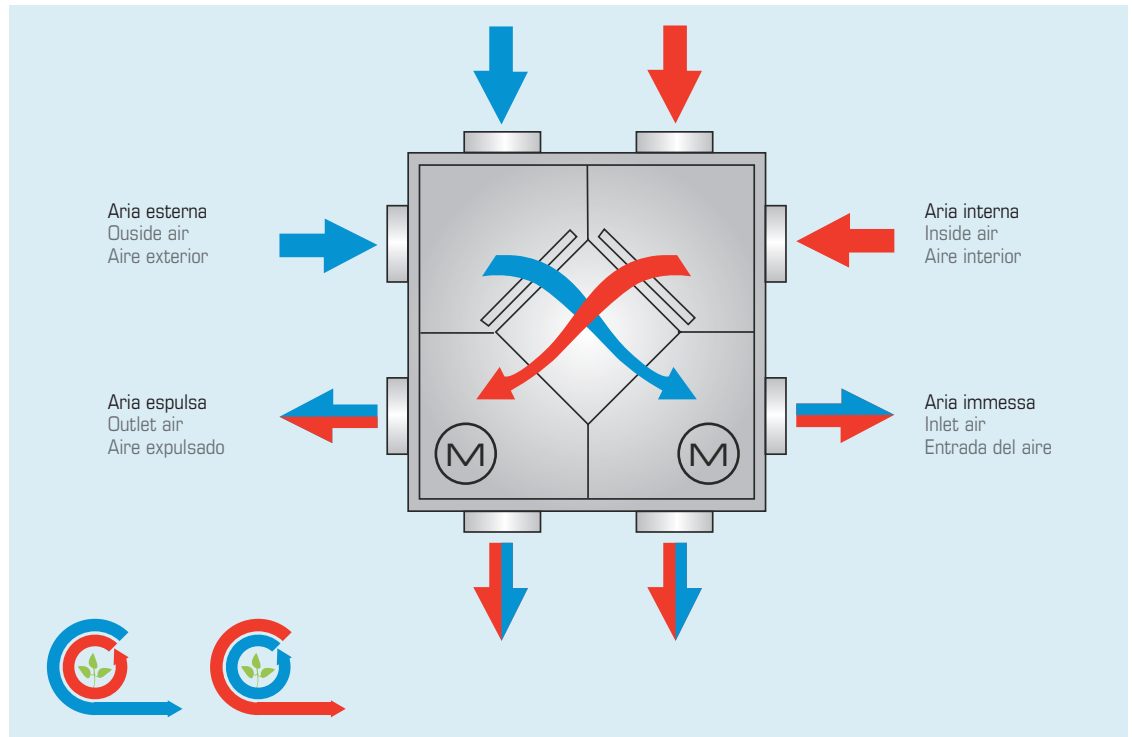
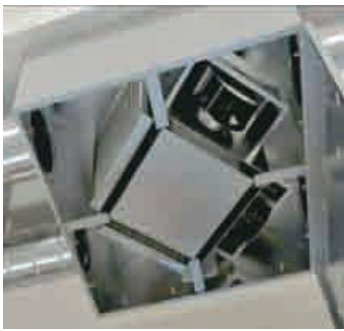

CONFIGURAZIONI RCA CONFIGURATION RCA CONFIGURACION RCA

VISTA DAL BASSO VIEW FROM BELOW VISTA DESDE ABAJO



Disposizione attacchi immissione/espulsione. Per RCA (montaggio orizzontale)
Inlet-outlet display connection. For RCA (horizontal installation)
Colocación de las conexiones de entrada/espulsión. Para RCA (montaje horizontal)

Collegamento elettrico
Electrical connection
Conexiones eléctricas

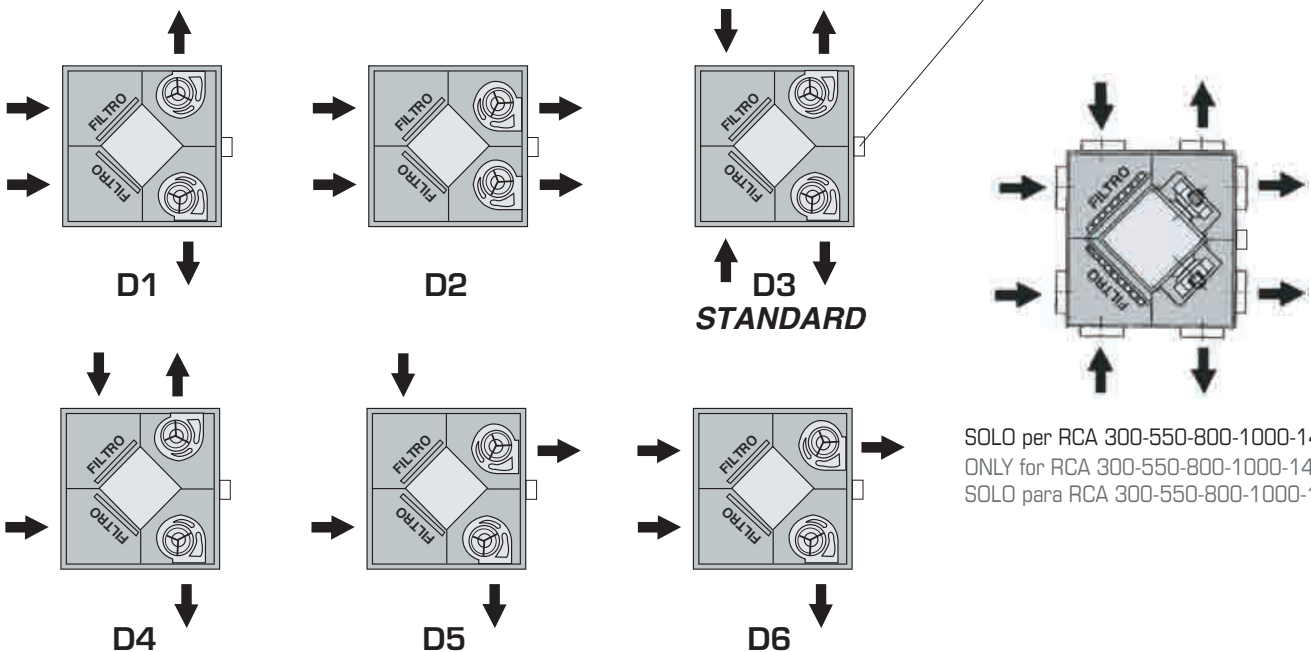

SOLO per RCA 300-550-800-1000-1400
ONLY for RCA 300-550-800-1000-1400
SOLO para RCA 300-550-800-1000-1400

SCHEDA DI FUNZIONAMENTO AERAUICO

AIR-FLOW SCHEDULE

FICHA TECNICA

RCA-V

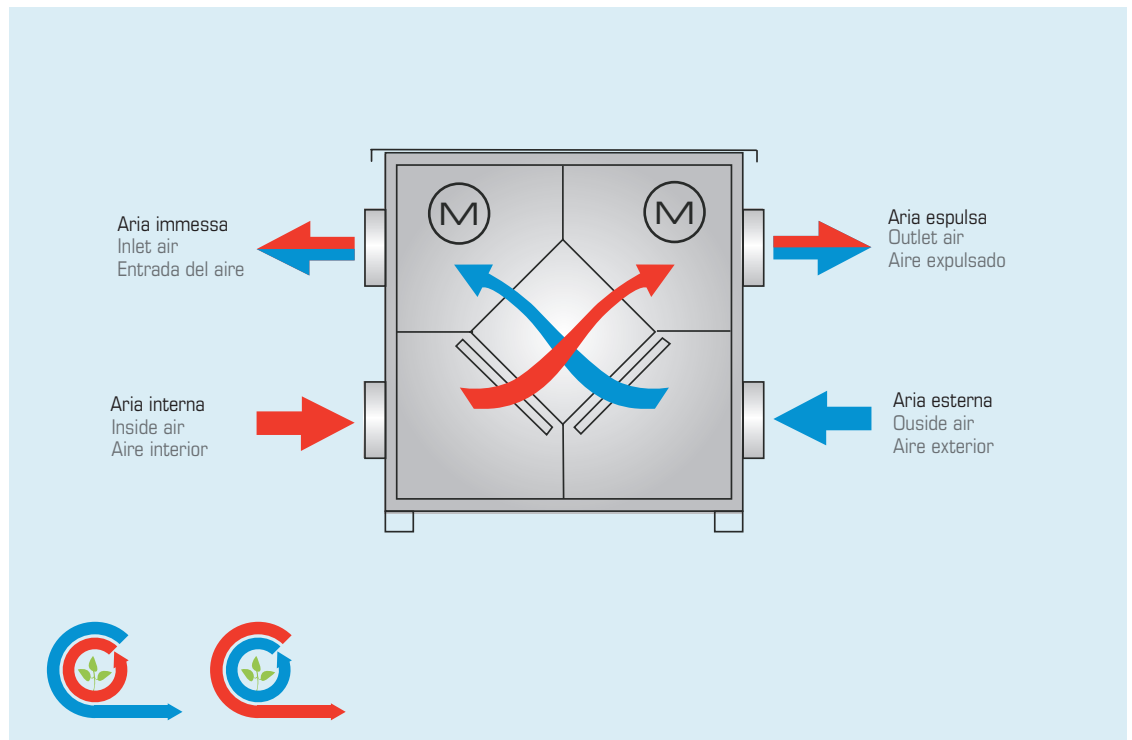
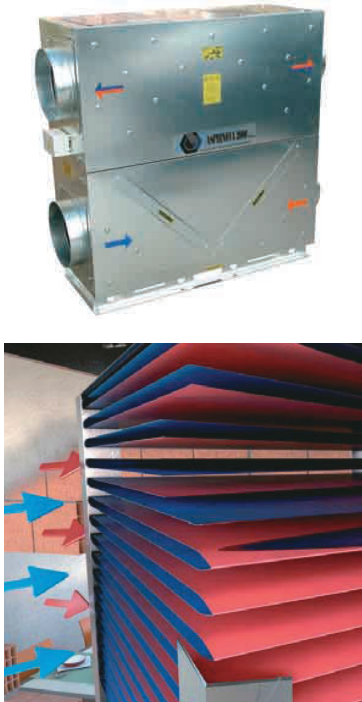

CONFIGURAZIONI RCA-V

CONFIGURATION RCA-V
CONFIGURACION RCA-V

Disposizione attacchi immissione/espulsione. Per RCA-V (montaggio verticale)
Inlet-outlet display connection. For RCA-V (vertical installation)
Colocación de las conexiones de entrada/expulsión. Para RCA-V (montaje vertical)



Collegamento elettrico
Electrical connection
Conexiones eléctricas

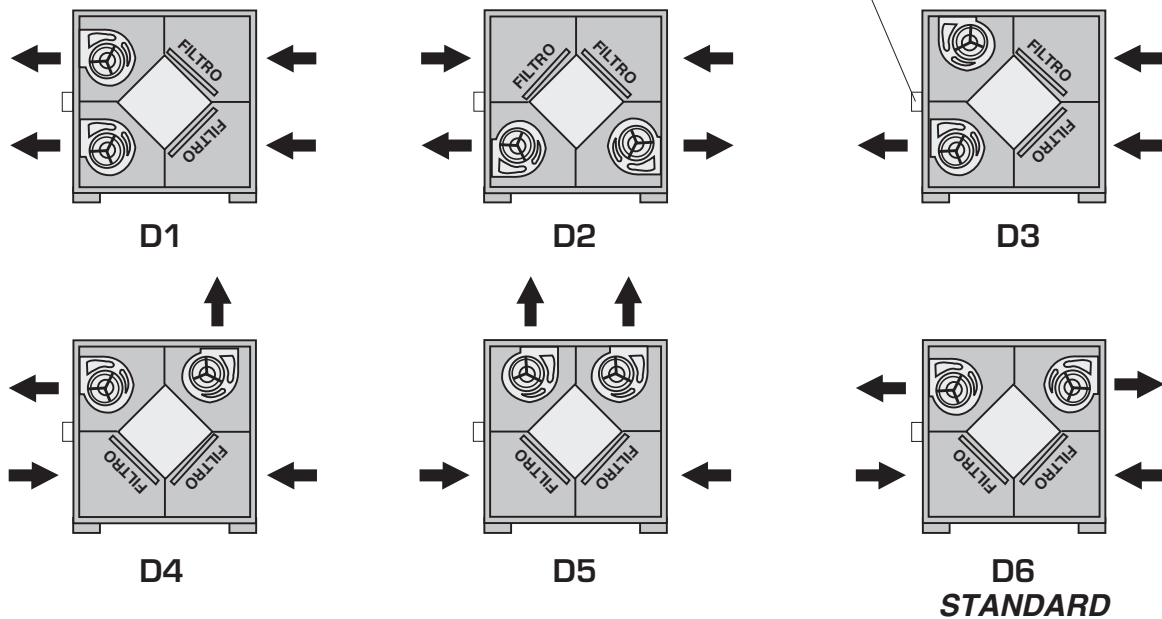

RECUPERATORI DI CALORE SERIE "RCA"

TIPO RCA 300 - 550 - 800 - 1000 - 1400

HEAT RECUPERATOR "RCA" SERIES

TYPE RCA 300 - 550 - 800 - 1000 - 1400

RECUPERADORES DE CALOR SERIE "RCA"

TIPO RCA 300 - 550 - 800 - 1000 - 1400

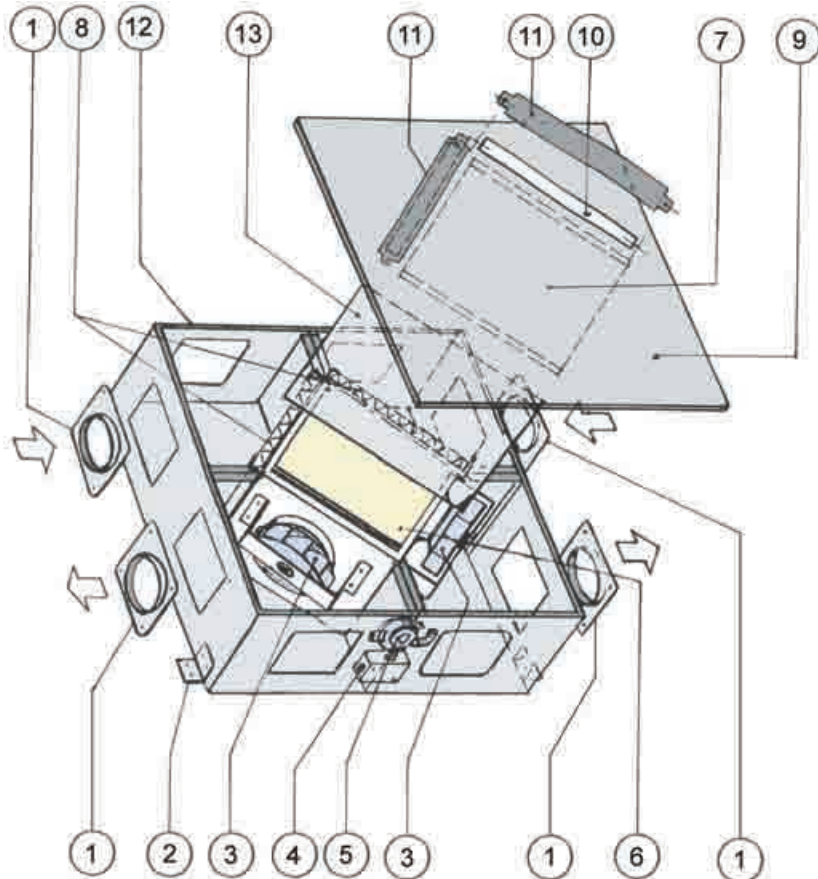

01	I ATTACCHI ENTRATA/USCITA	GB INLET/OUTLET CONNECTIONS	E CONEXIONES DE ENTRADA/SALIDA
02	STAFFE DI SOSTEGNO (N° 4 PEZZI)	SUPPORTING EYEBOLT (N° 4 PIECES)	PALOMILLA DE SOPORTE (N° 4 PIEZAS)
03	MOTORE/GIRANTE CENTRIFUGA	CENTRIFUGAL IMPELLER/MOTOR	MOTOVENTILADOR CENTRIFUGO
04	SCATOLA MORSETTIERA IP55	TERMINAL BOARD IP55	CAJA DE CONXIONES IP55
05	PRESSOSTATO (SU RICHIESTA)	PRESSURE SWITCH (ON REQUEST)	PRESOSTATO (A PETICION)
06	PACCO DI SCAMBIO TERMICO	RECUPERATOR	RECUPERADOR DE PLACAS
07	BACINELLA RACCOLTA CONDENZA	CONDENSE DISCHARGE DROP TANK	BANDEJA DE CONDENSADOS
08	FILTRI ACRILICI	FILTERS	FILTROS ACRILICOS
09	COPERCHIO INVOLUCRO	CASE COVER	TAPA DE MUEBLE
10	PASSAGGIO FILTRI	FILTERS SLOTS	PASO DE LOS FILTROS
11	CHIUSURA PASSAGGIO FILTRI	FILTERS BLOCK	TAPA DE FILTROS
12	INVOLUCRO	CASE	MUEBLE DE CHAPA
13	PANNELLO DI CHIUSURA PACCO DI SCAMBIO	RECUPERATOR FIXING PANEL	PANEL DE CIERRE DEL INTERCAMBIADOR

RECUPERATORI DI CALORE SERIE "RCA"

TIPO RCA 1800-2000-2600-3000-3500-4200-5500-6500-7000

HEAT RECUPERATOR "RCA" SERIES

TYPE RCA 1800-2000-2600-3000-3500-4200-5500-6500-7000

RECUPERADORES DE CALOR SERIE "RCA"

TIPO RCA 1800-2000-2600-3000-3500-4200-5500-6500-7000

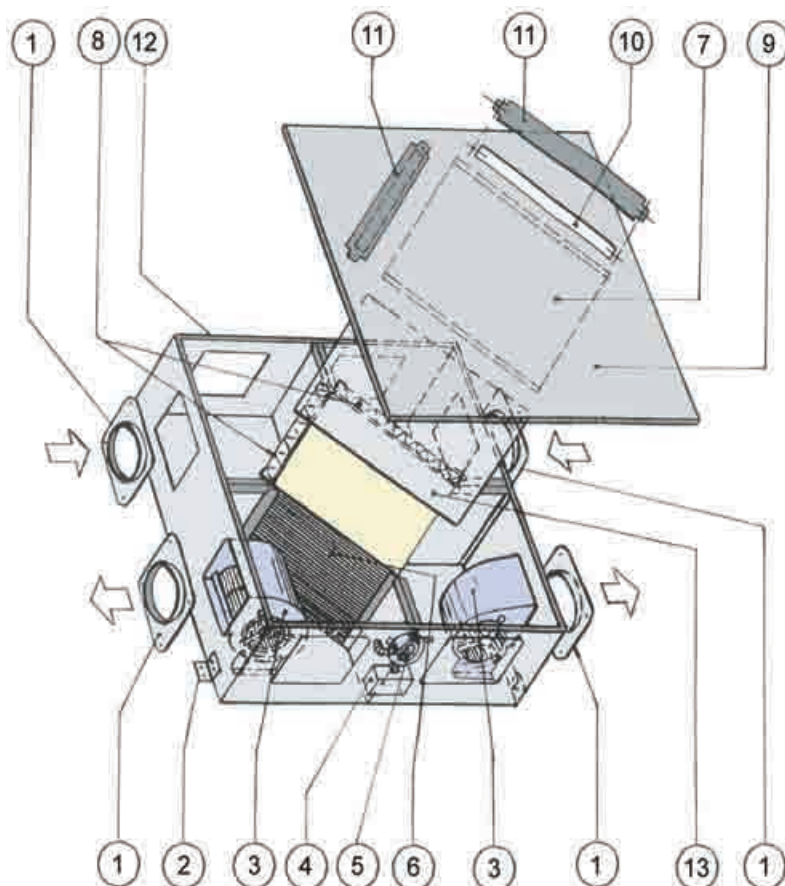

01	I ATTACCHI ENTRATA/USCITA	GB INLET/OUTLET CONNECTIONS	E CONEXIONES DE ENTRADA/SALIDA
02	TETTO PER ESTERNO (SU RICHIESTA)	OUTSIDE COVER (ON REQUEST)	PALOMILLA DE SOPORTE (N. 4 PIEZAS)
03	VENTILATORE CENTRIFUGO	CENTRIFUGAL FAN	VENTILADOR CENTRIFUGO
04	SCATOLA MORSETTIERA IP55	TERMINAL BOARD IP55	CAJA DE CONXIONES IP55
05	PRESSOSTATO (SU RICHIESTA)	PRESSURE SWITCH (ON REQUEST)	PRESOSTATO (A PETICION)
06	PACCO DI SCAMBIO TERMICO	RECUPERATOR	RECUPERADOR DE PLACAS
07	BACINELLA RACCOLTA CONDENZA	CONDENSE DISCHARGE DROP TANK	BANDEJA DE CONDENSADOS
08	FILTRI ACRILICI	FILTERS	FILTROS ACRILICOS
09	COPERCHIO INVOLUCRO	CASE COVER	TAPA DE MUEBLE
10	PASSAGGIO FILTRI	FILTERS SLOTS	PASO DE LOS FILTROS
11	CHIUSURA PASSAGGIO FILTRI	FILTERS BLOCK	TAPA DE FILTROS
12	INVOLUCRO	CASE	MUEBLE DE CHAPA
13	PANNELLO DI CHIUSURA PACCO DI SCAMBIO	RECUPERATOR FIXING PANEL	PANEL DE CIERRE DEL INTERCAMBIADOR

RECUPERATORI DI CALORE SERIE "RCA-V"

TIPO RCA-V 300 - 550 - 800 - 1000 - 1400

HEAT RECUPERATOR "RCA-V" SERIES

TYPE RCA-V 300 - 550 - 800 - 1000 - 1400

RECUPERADORES DE CALOR SERIE "RCA-V"

TIPO RCA-V 300 - 550 - 800 - 1000 - 1400

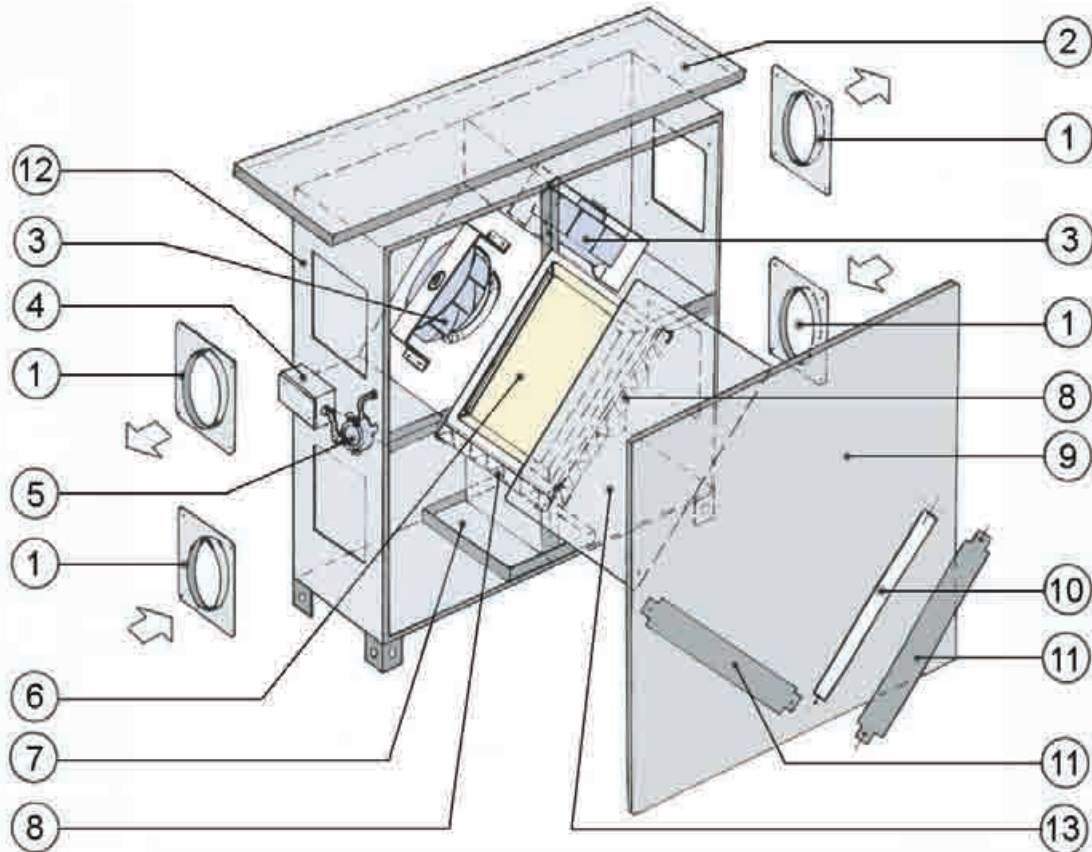

	I	GB	E
01	I ATTACCHI ENTRATA/USCITA	GB INLET/OUTLET CONNECTIONS	E CONEXIONES DE ENTRADA/SALIDA
02	TETTO PER ESTERNO (SU RICHIESTA)	OUTSIDE COVER (ON REQUEST)	TEJADILLO INTEMPERIE (BAJO PEDIDO)
03	MOTORE/GIRANTE CENTRIFUGA	CENTRIFUGAL IMPELLER/MOTOR	MOTOVENTILADOR CENTRIFUGO
04	SCATOLA MORSETTIERA IP55	TERMINAL BOARD IP55	CAJA DE CONXIONES IP55
05	PRESSOSTATO (SU RICHIESTA)	PRESSURE SWITCH (ON REQUEST)	PRESOSTATO (A PETICION)
06	PACCO DI SCAMBIO TERMICO	RECUPERATOR	RECUPERADOR DE PLACAS
07	BACINELLA RACCOLTA CONDENZA	CONDENSE DISCHARGE DROP TANK	BANDEJA DE CONDENSADOS
08	FILTRI ACRILICI	FILTERS	FILTROS ACRILICOS
09	COPERCHIO INVOLUCRO	CASE COVER	TAPA DE MUEBLE
10	PASSAGGIO FILTRI	FILTERS SLOTS	PASO DE LOS FILTROS
11	CHIUSURA PASSAGGIO FILTRI	FILTERS BLOCK	TAPA DE FILTROS
12	INVOLUCRO	CASE	MUEBLE DE CHAPA
13	PANNELLO DI CHIUSURA PACCO DI SCAMBIO	RECUPERATOR FIXING PANEL	PANEL DE CIERRE DEL INTERCAMBIADOR

RECUPERATORI DI CALORE SERIE "RCA-V"

TIPO RCA-V 1800-2000-2600-3000-3500-4200-5500-6500-7000

HEAT RECUPERATOR "RCA-V" SERIES

TYPE RCA-V 1800-2000-2600-3000-3500-4200-5500-6500-7000

RECUPERADORES DE CALOR SERIE "RCA-V"

TIPO RCA-V 1800-2000-2600-3000-3500-4200-5500-6500-7000

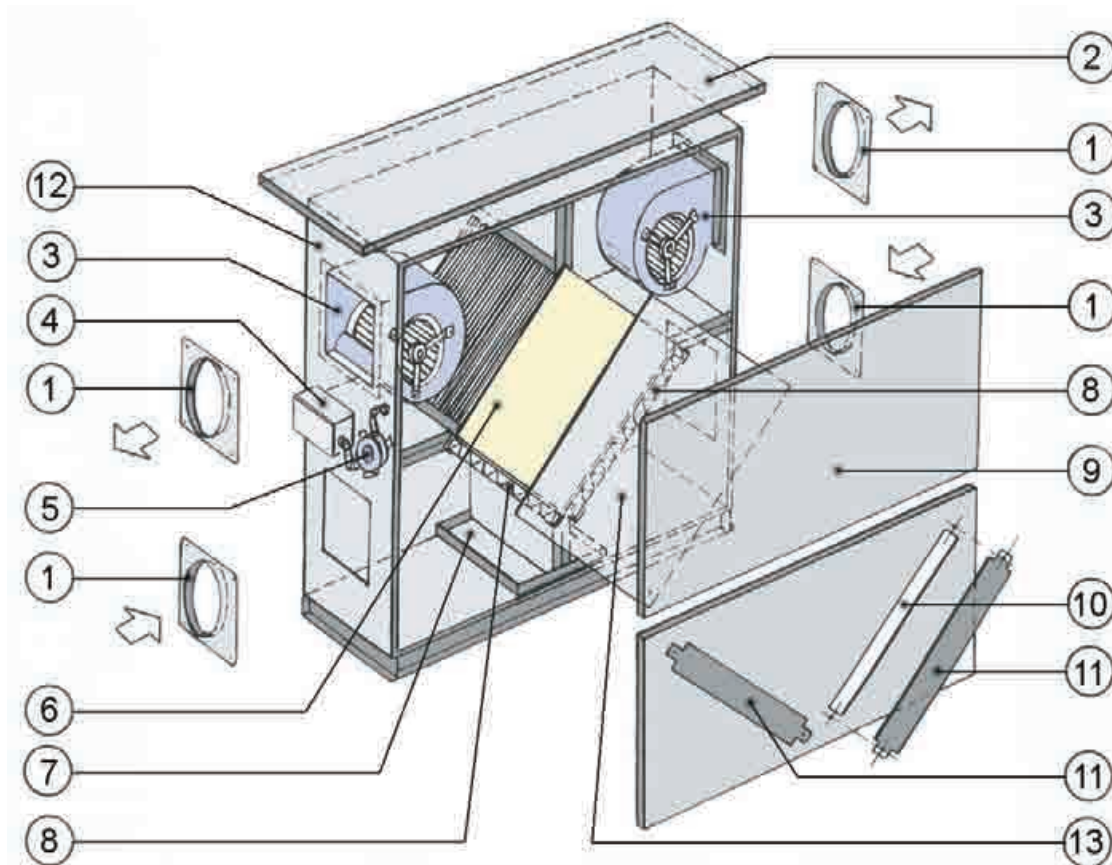

01	(I) ATTACCHI ENTRATA/USCITA	(GB) INLET/OUTLET CONNECTIONS	(E) CONEXIONES DE ENTRADA/SALIDA
02	TETTO PER ESTERNO (SU RICHIESTA)	OUTSIDE COVER (ON REQUEST)	TEJADILLO INTEMPERIE (BAJO PEDIDO)
03	VENTILATORE CENTRIFUGO	CENTRIFUGAL FAN	VENTILADOR CENTRIFUGO
04	SCATOLA MORSETTIERA IP55	TERMINAL BOARD IP55	CAJA DE CONXIONES IP55
05	PRESSOSTATO (SU RICHIESTA)	PRESSURE SWITCH (ON REQUEST)	PRESOSTATO (A PETICION)
06	PACCO DI SCAMBIO TERMICO	RECUPERATOR	RECUPERADOR DE PLACAS
07	BACINELLA RACCOLTA CONDENZA	CONDENSE DISCHARGE DROP TANK	BANDEJA DE CONDENSADOS
08	FILTRI ACRILICI	FILTERS	FILTROS ACRILICOS
09	COPERCHIO INVOLUCRO	CASE COVER	TAPA DE MUEBLE
10	PASSAGGIO FILTRI	FILTERS SLOTS	PASO DE LOS FILTROS
11	CHIUSURA PASSAGGIO FILTRI	FILTERS BLOCK	TAPA DE FILTROS
12	INVOLUCRO	CASE	MUEBLE DE CHAPA
13	PANNELLO DI CHIUSURA PACCO DI SCAMBIO	RECUPERATOR FIXING PANEL	PANEL DE CIERRE DEL INTERCAMBIADOR

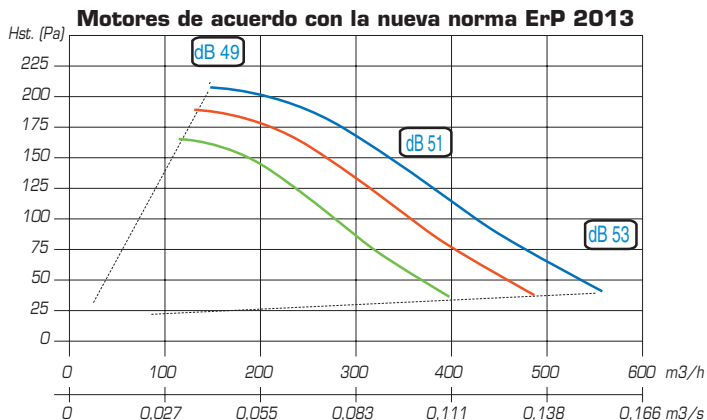

- Filtri interni F6-F7 / Inside Filter class F6-F7 / Filtros internos F6-F7
- Filtri F6-F7 + Filtro tasche esterno F8-F9 / Filtros F6-F7 + filtro a bolsas externo F8-F9
- Filtri F6-F7 + batteria acqua calda interna / Filtros F6-F7 + batería de agua caliente

RCA 550

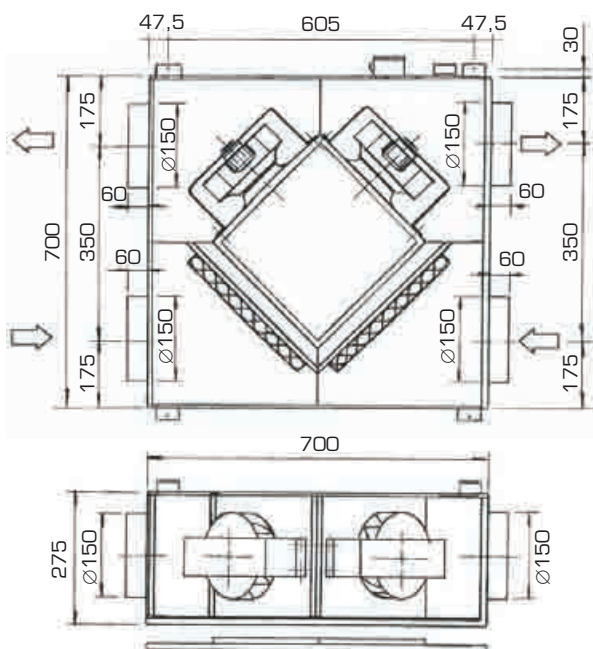

RCA-V 550

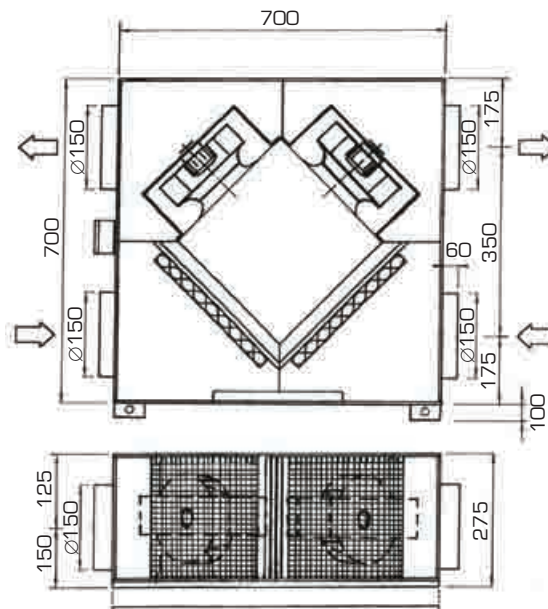

I valori sopraindicati sono stati calcolati secondo la norma europea EN 308.

The above values are calculated in reference to the european norm EN 308.

Los valores indicados arriba se han calculado según la norma europea EN 308.

- Su richiesta pacchi di scambio con maggiore efficienza
- On request Exchanger with higher efficiency
- Bajo demanda recuperadores de placas con mayor eficacia

Portata Aria	Aria Ambiente	Aria Rinnovo	Aria Rinnovo	Aria Trattata	Efficienza	Potenza Recuperatore
Capacity Air	Air Ambiente	Air Rinnovo	Air Rinnovo	Air Trattata	Efficiency	Power Recuperators
Capacidad Aire	Aire Ambiente	Aire Recambio	Aire Recambio	Aire Tratada	Eficiencia	Potencia Recuperador
m³/h	°C	°C	R.H. %	°C	%	KW
550	20	-5	80	10,2	61	2,8
550	26	34	50	29,5	56	0,71



[dB] Lp - Livelli di pressione sonora dB(A) - ISO 3741 - rilevati alla distanza di mt. 2 in campo libero dal centro dei recuperatori con canalizzazioni in immissione/estrazione

Modello / Type / Modelo	Volt / Hz / PH	W	Ampere	Regolatore / Speed Controller / Regulador
RCA / RCA-V 550	230 / 50 / 1	2 x 85	2 x 0,38	1 x RMD 5
Filtri / Filters / Filtros acrílicos		Peso / Weight / Peso		Imballo Scatola / Box Packing / Embalaje Caja
F6 N° 2 FP - 340 x 240 x 25		32 kg		mm. 900 x 800 x H.340

Filtri acrilici / Filters / Filtros acrílicos F7 - F8 (OPTIONAL)

Motore de acuerdo con la nueva norma ErP 2013

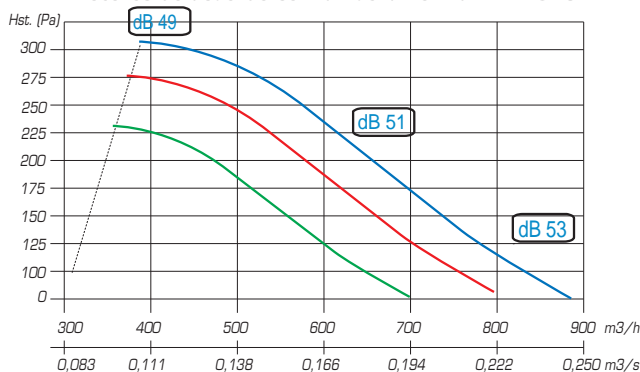

- Filtri interni F6-F7 / Inside Filter class F6-F7 / Filtros internos F6-F7
- Filtri F6-F7 + Filtro tasche esterno F8-F9 / Filtros F6-F7 + filtro a bolsas externo F8-F9
- Filtri F6-F7 + batteria acqua calda esterna / Filtros F6-F7 + batería de agua caliente

RCA 800

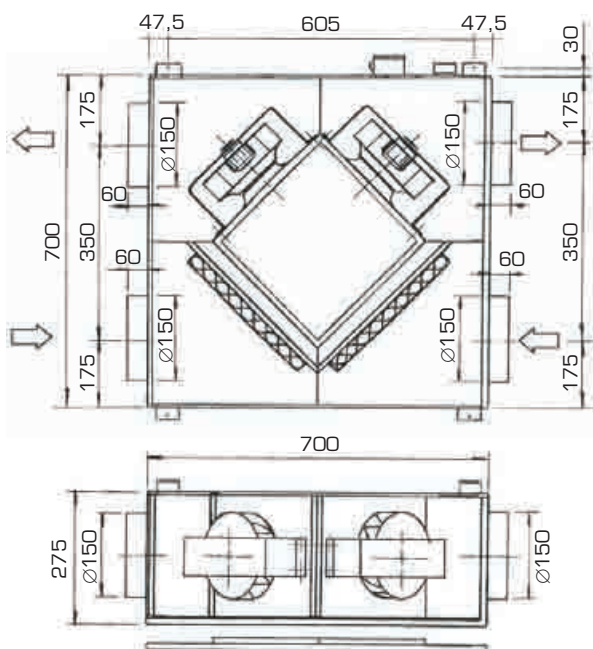

RCA-V 800

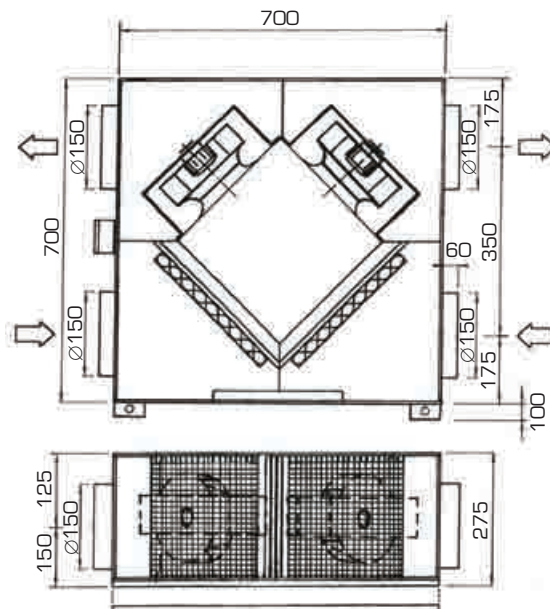

I valori sopraindicati sono stati calcolati secondo la norma europea EN 308.

The above values are calculated in reference to the european norm EN 308.

Los valores indicados arriba se han calculado según la norma europea EN 308.

- Su richiesta pacchi di scambio con maggiore efficienza
- On request Exchanger with higher efficiency
- Bajo demanda recuperadores de placas con mayor eficacia

Portata Aria	Aria Ambiente	Aria Rinnovo	Aria Rinnovo	Aria Trattata	Efficienza	Potenza Recuperatore
Capacity Air	Aire Ambiente	Aire Rinnovo	Aire Rinnovo	Aire Trattata	Efficiency	Power Recuperators
Capacidad Aire	Aire Ambiente	Aire Recambio	Aire Recambio	Aire Tratada	Eficiencia	Potencia Recuperador
m³/h	°C	°C	R.H. %	°C	%	KW
800	20	-5	80	9,9	60	3,8
800	26	34	50	29,6	54	0,97



[dB] Lp - Livelli di pressione sonora dB(A) - ISO 3741 - rilevati alla distanza di mt. 2 in campo libero dal centro dei recuperatori con canalizzazioni in immissione/estrazione

Modello / Type / Modelo	Volt / Hz / PH	W	Ampere	Regolatore / Speed Controller / Regulador
RCA / RCA-V 800	230 / 50 / 1	2 x 155	2 x 0,68	1 x RMD 5
Filtri / Filters / Filtros acrílicos		Peso / Weight / Peso		Imballo Scatola / Box Packing / Embalaje Caja
F6 N° 2 FP - 340 x 240 x 25		34 kg		mm. 900 x 800 x H.340

Filtri acrilici / Filters / Filtros acrílicos F7 - F8 (OPTIONAL)

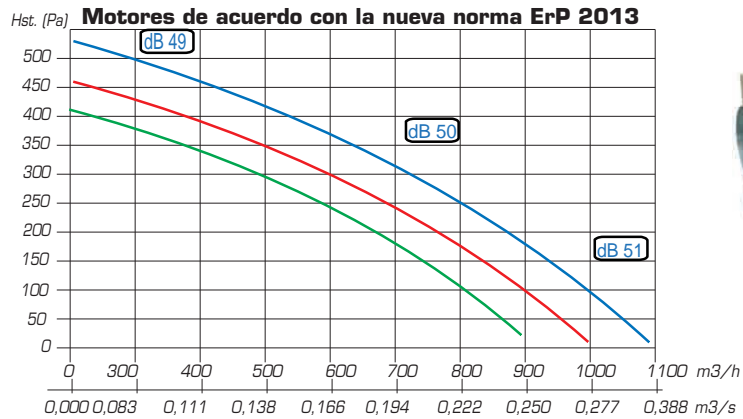

- Filtri interni F6-F7 / Inside Filter class F6-F7 / Filtros internos F6-F7
- Filtri F6-F7 + Filtro tasche esterno F8-F9 / Filtros F6-F7 + filtro a bolsas externo F8-F9
- Filtri F6-F7 + batteria acqua calda esterna / Filtros F6-F7 + batería de agua caliente

RCA 1000

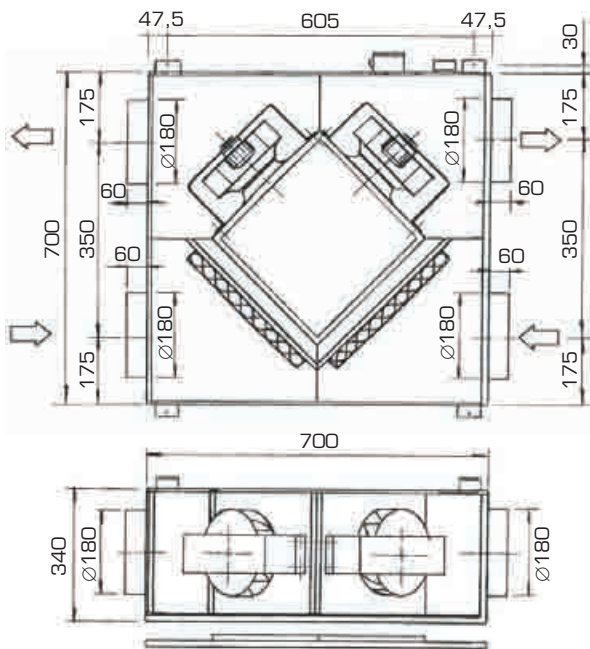

RCA-V 1000

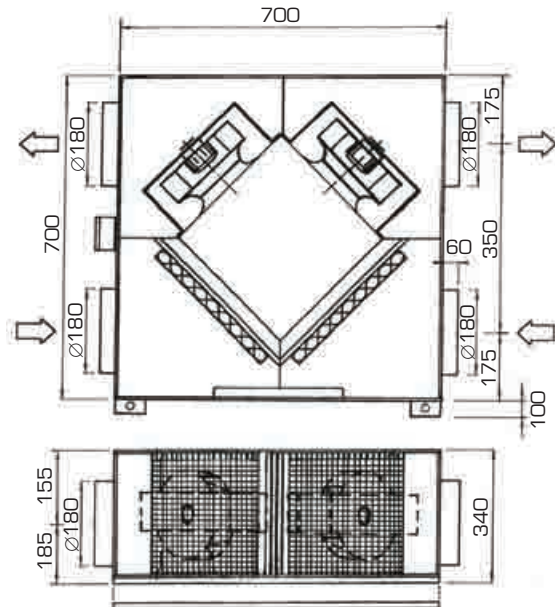

I valori sopraindicati sono stati calcolati secondo la norma europea EN 308.

The above values are calculated in reference to the european norm EN 308.

Los valores indicados arriba se han calculado según la norma europea EN 308.

- Su richiesta pacchi di scambio con maggiore efficienza
- On request Exchanger with higher efficiency
- Bajo demanda recuperadores de placas con mayor eficacia

Portata Aria	Aria Ambiente	Aria Rinnovo	Aria Rinnovo	Aria Trattata	Efficienza	Potenza Recuperatore
Capacity Air	Air Ambiente	Air Rinnovo	Air Rinnovo	Air Trattata	Efficiency	Power Recuperators
Capacidad Aire	Aire Ambiente	Aire Recambio	Aire Recambio	Aire Tratada	Eficiencia	Potencia Recuperador
m³/h	°C	°C	R.H. %	°C	%	KW
1000	20	-5	80	9,2	57	5,2
1000	26	34	50	30,1	48	1,2



[dB] Lp - Livelli di pressione sonora dB(A) - ISO 3741 - rilevati alla distanza di mt. 2 in campo libero dal centro dei recuperatori con canalizzazioni in immissione/estrazione

Modello / Type / Modelo	Volt / Hz / PH	W	Ampere	Regolatore / Speed Controller / Regulador
RCA / RCA-V 1000	230 / 50 / 1	2 x 210	2 x 0,93	1 x RMD 5
Filtri / Filters / Filtros acrílicos		Peso / Weight / Peso		Imballo Scatola / Box Packing / Embalaje Caja
F6 N° 2 FP - 340 x 300 x 25		40 kg		mm. 900 x 800 x H.360

Filtri acrilici / Filters / Filtros acrílicos F7 - F8 (OPTIONAL)

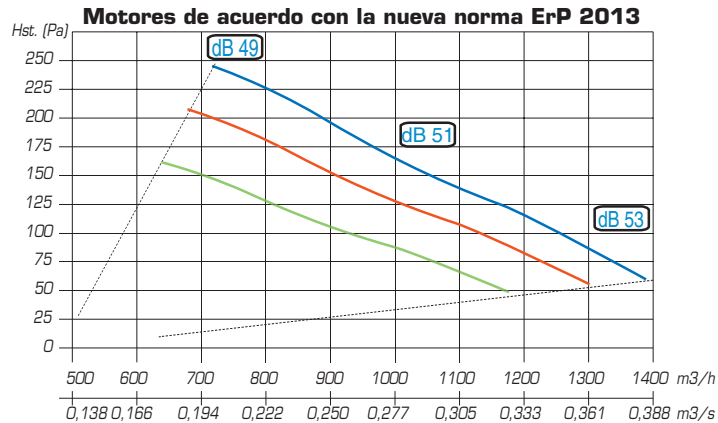

- Filtri interni F6-F7 / Inside Filter class F6-F7 / Filtros internos F6-F7
- Filtri F6-F7 + Filtro tasche esterno F8-F9 / Filtros F6-F7 + filtro a bolsas esterno F8-F9
- Filtri F6-F7 + batteria acqua calda esterna / Filtros F6-F7 + batería de agua caliente

RCA 1400

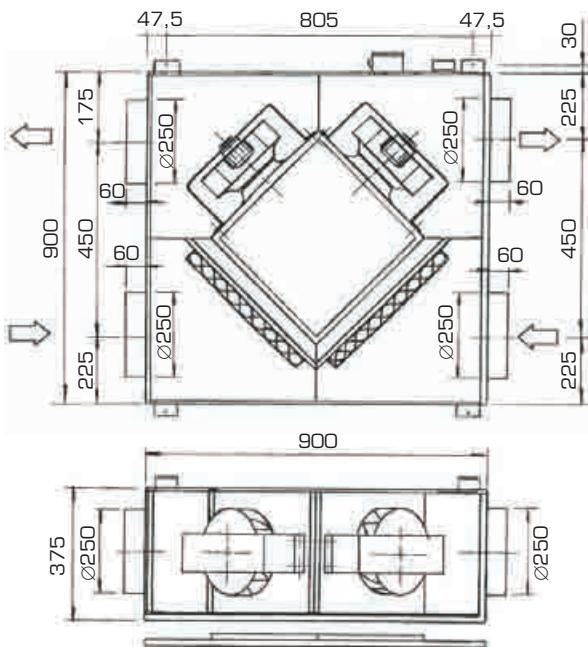

RCA-V 1400

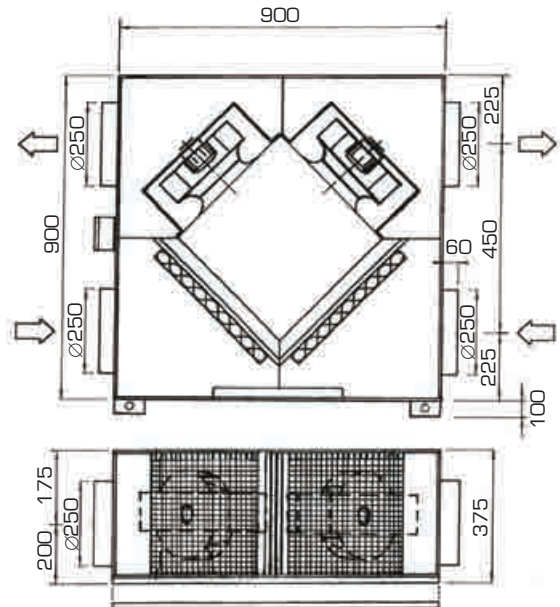

I valori sopraindicati sono stati calcolati secondo la norma europea EN 308.

The above values are calculated in reference to the european norm EN 308.

Los valores indicados arriba se han calculado según la norma europea EN 308.

- Su richiesta pacchi di scambio con maggiore efficienza
- On request Exchanger with higher efficiency
- Bajo demanda recuperadores de placas con mayor eficacia

Portata Aria	Aria Ambiente	Aria Rinnovo	Aria Rinnovo	Aria Trattata	Efficienza	Potenza Recuperatore
Capacity Air	Air Ambiente	Air Rinnovo	Air Rinnovo	Air Trattata	Efficiency	Power Recuperators
Capacidad Aire	Aire Ambiente	Aire Recambio	Aire Recambio	Aire Tratada	Eficiencia	Potencia Recuperador
m³/h	°C	°C	R.H. %	°C	%	KW
1400	20	-5	80	9,2	57	6,7
1400	26	34	50	30,1	49	1,6



[dB] Lp - Livelli di pressione sonora dB(A) - ISO 3741 - rilevati alla distanza di mt. 2 in campo libero dal centro dei recuperatori con canalizzazioni in immissione/estrazione

Modello / Type / Modelo	Volt / Hz / PH	W	Ampere	Regolatore / Speed Controller / Regulador
RCA / RCA-V 1400	230 / 50 / 1	2 x 230	2 x 1,05	1 x RMD 5
Filtri / Filters / Filtros acrílicos		Peso / Weight / Peso		Imballo Scatola / Box Packing / Embalaje Caja
F6 N° 2 FP - 450 x 340 x 25		65 kg		mm. 1030 x 1030 x H.460

Filtri acrilici / Filters / Filtros acrílicos F7 - F8 (OPTIONAL)



Motore di accordo con la nuova norma ErP 2013

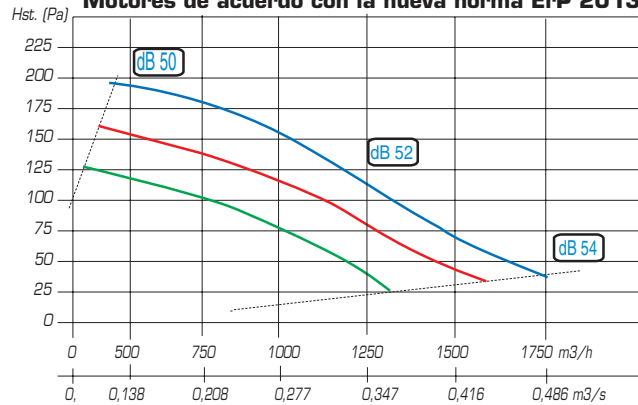

- Filtri interni F6-F7 / Inside Filter class F6-F7 / Filtros internos F6-F7
- Filtri F6-F7 + Filtro tasche esterno F8-F9 / Filtros F6-F7 + filtro a bolsas externo F8-F9
- Filtri F6-F7 + batteria acqua calda esterna / Filtros F6-F7 + batería de agua caliente

RCA 1800

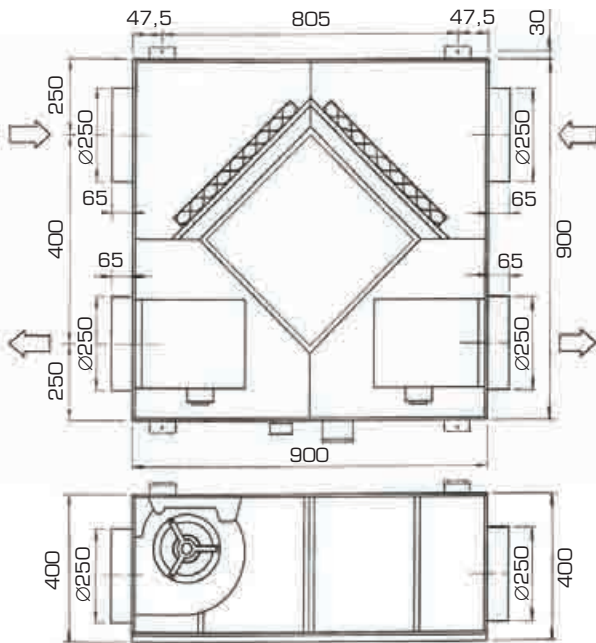

RCA-V 1800

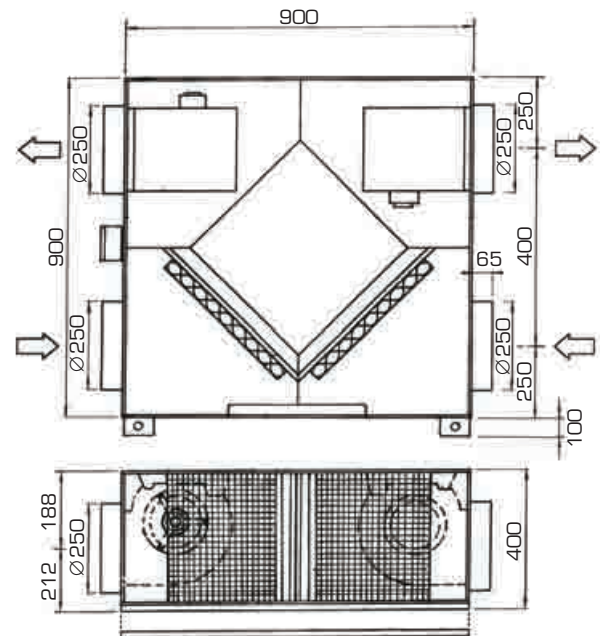

I valori sopraindicati sono stati calcolati secondo la norma europea EN 308.

The above values are calculated in reference to the european norm EN 308.

Los valores indicados arriba se han calculado según la norma europea EN 308.

- Su richiesta pacchi di scambio con maggiore efficienza
- On request Exchanger with higher efficiency
- Bajo demanda recuperadores de placas con mayor eficacia

Portata Aria	Aria Ambiente	Aria Rinnovo	Aria Rinnovo	Aria Trattata	Efficienza	Potenza Recuperatore
Capacity Air	Air Ambiente	Air Rinnovo	Air Rinnovo	Air Trattata	Efficiency	Power Recuperators
Capacidad Aire	Aire Ambiente	Aire Recambio	Aire Recambio	Aire Tratada	Eficiencia	Potencia Recuperador
m³/h	°C	°C	R.H. %	°C	%	KW
1800	20	-5	80	10,1	61	11
1800	26	34	50	29,8	52	2,7



[dB] Lp - Livelli di pressione sonora dB(A) - ISO 3741 - rilevati alla distanza di mt. 2 in campo libero dal centro dei recuperatori con canalizzazioni in immissione/estrazione

Modello / Type / Modelo	Volt / Hz / PH	W	Ampere	Regolatore / Speed Controller / Regulador
RCA / RCA-V 1800	230 / 50 / 1	2 x 300	2 x 2,50	1 x RMD 10
Filtri / Filters / Filtros acrílicos		Peso / Weight / Peso		Imballo Scatola / Box Packing / Embalaje Caja
F6 N° 2 FO - 450 x 365 x 25		105 kg		mm. 1030 x 1030 x H.460

Filtri acrilici / Filters / Filtros acrílicos F7 - F8 (OPTIONAL)

RCA-H 2000

RCA-V 2000

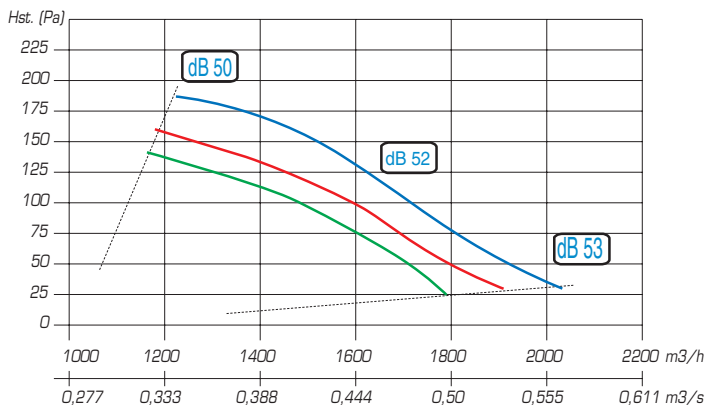

- Filtri interni F6-F7 / Inside Filter class F6-F7 / Filtros internos F6-F7
- Filtri F6-F7 + Filtro tasche esterno F8-F9 / Filtros F6-F7 + filtro a bolsas externo F8-F9
- Filtri F6-F7 + batteria acqua calda esterna / Filtros F6-F7 + batería de agua caliente

RCA 2000

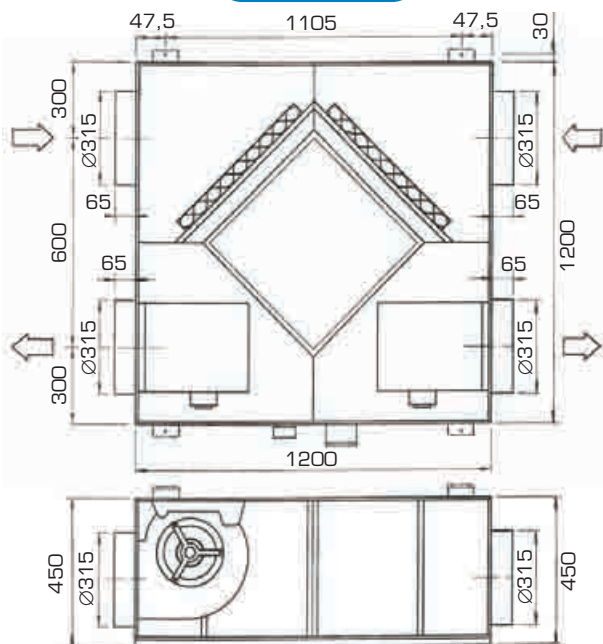

RCA-V 2000

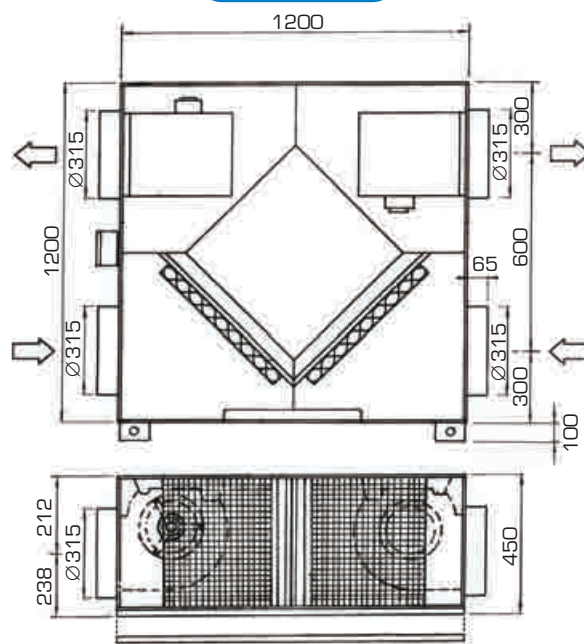

I valori sopraindicati sono stati calcolati secondo la norma europea EN 308.

The above values are calculated in reference to the european norm EN 308.

Los valores indicados arriba se han calculado según la norma europea EN 308.

- Su richiesta pacchi di scambio con maggiore efficienza
- On request Exchanger with higher efficiency
- Bajo demanda recuperadores de placas con mayor eficacia

Portata Aria	Aria Ambiente	Aria Rinnovo	Aria Rinnovo	Aria Trattata	Efficienza	Potenza Recuperatore
Capacity Air	Air Ambiente	Air Rinnovo	Air Rinnovo	Air Trattata	Efficiency	Power Recuperators
Capacidad Aire	Aire Ambiente	Aire Recambio	Aire Recambio	Aire Tratada	Eficiencia	Potencia Recuperador
m³/h	°C	°C	R.H. %	°C	%	KW
2000	20	-5	80	10,1	61	11
2000	26	34	50	29,8	52	2,7



dB Lp - Livelli di pressione sonora dB(A) - ISO 3741 - rilevati alla distanza di mt. 2 in campo libero dal centro dei recuperatori con canalizzazioni in immissione/estrazione

Modello / Type / Modelo	Volt / Hz / PH	W	Ampere	Regolatore / Speed Controller / Regulador
RCA / RCA-V 2000	230 / 50 / 1	2 x 147	2 x 1,50	1 x RMD 5
Filtri / Filters / Filtros acrílicos		Peso / Weight / Peso		Imballo Scatola / Box Packing / Embalaje Caja
F6 N° 2 FO - 500 x 400 x 48		120 kg		mm. 500 x 1350 x H.1500

Filtri acrilici / Filters / Filtros acrílicos F7 - F8 (OPTIONAL)

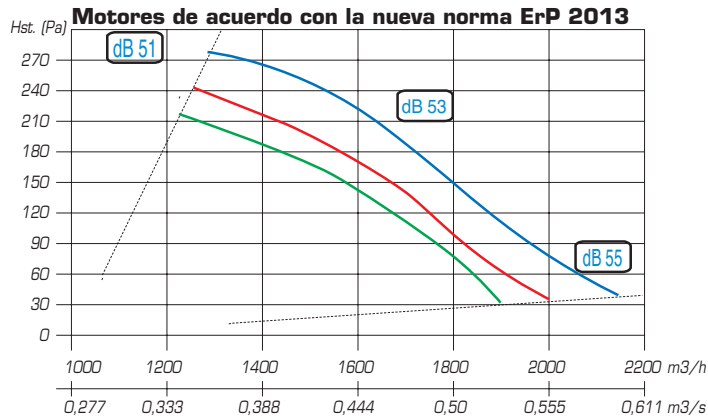

- Filtri interni F6-F7 / Inside Filter class F6-F7 / Filtros internos F6-F7
- Filtri F6-F7 + Filtro tasche esterno F8-F9 / Filtros F6-F7 + filtro a bolsas externo F8-F9
- Filtri F6-F7 + batteria acqua calda esterna / Filtros F6-F7 + batería de agua caliente

RCA 2000 4P

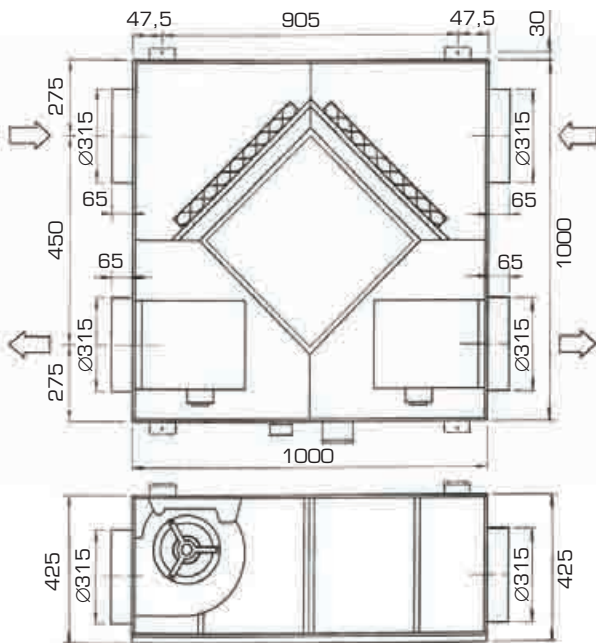

RCA-V 2000 4P

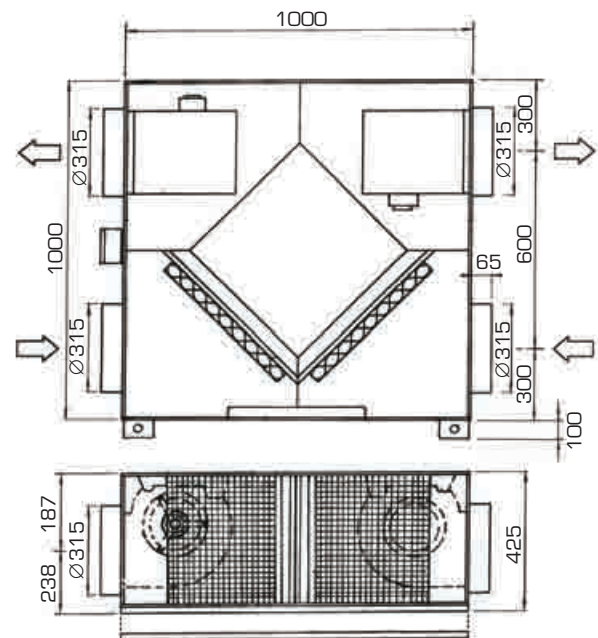

I valori sopraindicati sono stati calcolati secondo la norma europea EN 308.

The above values are calculated in reference to the european norm EN 308.

Los valores indicados arriba se han calculado según la norma europea EN 308.

- Su richiesta pacchi di scambio con maggiore efficienza
- On request Exchanger with higher efficiency
- Bajo demanda recuperadores de placas con mayor eficacia

Portata Aria	Aria Ambiente	Aria Rinnovo	Aria Rinnovo	Aria Trattata	Efficienza	Potenza Recuperatore
Capacity Air	Air Ambiente	Air Rinnovo	Air Rinnovo	Air Trattata	Efficiency	Power Recuperators
Capacidad Aire	Aire Ambiente	Aire Recambio	Aire Recambio	Aire Tratada	Eficiencia	Potencia Recuperador
m³/h	°C	°C	R.H. %	°C	%	KW
2000	20	-5	80	7,9	52	9,4
2000	26	34	50	29,8	50	2,6



[dB] Lp - Livelli di pressione sonora dB(A) - ISO 3741 - rilevati alla distanza di mt. 2 in campo libero dal centro dei recuperatori con canalizzazioni in immissione/estrazione

Modello / Type / Modelo	Volt / Hz / PH	W	Ampere	Regolatore / Speed Controller / Regulador
RCA / RCA-V 2000 4P	230 / 50 / 1	2 x 368	2 x 3,20	1 x RMD 10
Filtri / Filters / Filtros acrílicos		Peso / Weight / Peso		Imballo Scatola / Box Packing / Embalaje Caja
F6 N° 2 FO - 500 x 400 x 48		98 kg		mm. 500 x 1350 x H.1500

Filtri acrilici / Filters / Filtros acrílicos F7 - F8 (OPTIONAL)

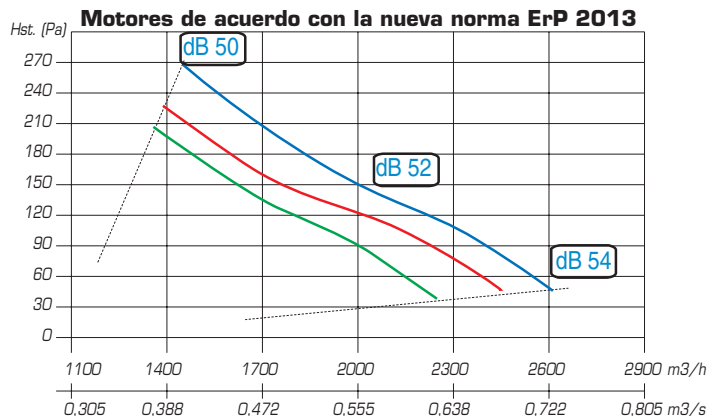

- Filtri interni F6-F7 / Inside Filter class F6-F7 / Filtros internos F6-F7
- Filtri F6-F7 + Filtro tasche esterno F8-F9 / Filtros F6-F7 + filtro a bolsas externo F8-F9
- Filtri F6-F7 + batteria acqua calda esterna / Filtros F6-F7 + batería de agua caliente

RCA 2600

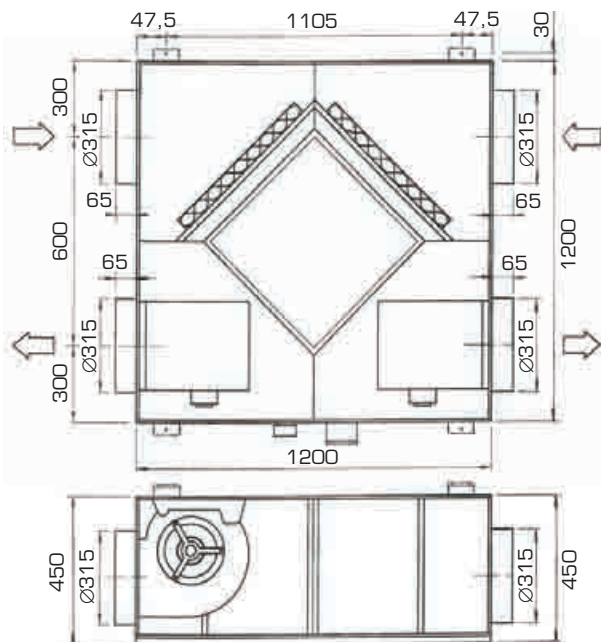

RCA-V 2600

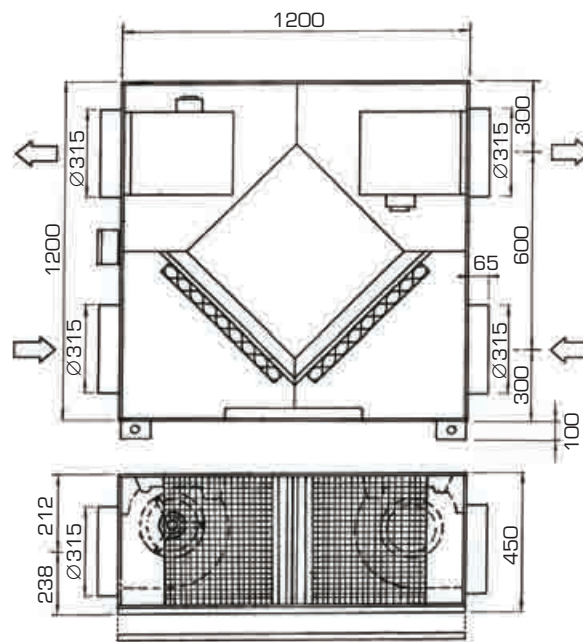

I valori sopraindicati sono stati calcolati secondo la norma europea EN 308.

The above values are calculated in reference to the european norm EN 308.

Los valores indicados arriba se han calculado según la norma europea EN 308.

- Su richiesta pacchi di scambio con maggiore efficienza
- On request Exchanger with higher efficiency
- Bajo demanda recuperadores de placas con mayor eficacia

Portata Aria	Aria Ambiente	Aria Rinnovo	Aria Rinnovo	Aria Trattata	Efficienza	Potenza Recuperatore
Capacity Air	Air Ambiente	Air Rinnovo	Air Rinnovo	Air Trattata	Efficiency	Power Recuperators
Capacidad Aire	Aire Ambiente	Aire Recambio	Aire Recambio	Aire Tratada	Eficiencia	Potencia Recuperador
m³/h	°C	°C	R.H. %	°C	%	KW
2600	20	-5	80	10,2	61	12
2600	26	34	50	29,8	52	3,5



[dB] Lp - Livelli di pressione sonora dB(A) - ISO 3741 - rilevati alla distanza di mt. 2 in campo libero dal centro dei recuperatori con canalizzazioni in immissione/estrazione

Modello / Type / Modelo	Volt / Hz / PH	W	Ampere	Regolatore / Speed Controller / Regulador
RCA / RCA-V 2600	230 / 50 / 1	2 x 368	2 x 3,20	1 x RMD 10
Filtri / Filters / Filtros acrílicos		Peso / Weight / Peso		Imballo Scatola / Box Packing / Embalaje Caja
F6 N° 2 FO - 500 x 400 x 48		130 kg		mm. 500 x 1350 x H.1500

Filtri acrilici / Filters / Filtros acrílicos F7 - F8 (OPTIONAL)

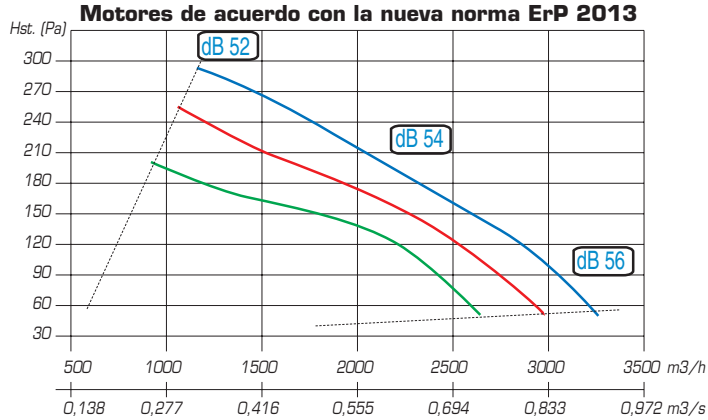
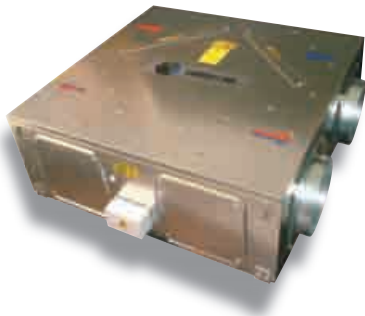

- Filtri interni F6-F7 / Inside Filter class F6-F7 / Filtros internos F6-F7
- Filtri F6-F7 + Filtro tasche esterno F8-F9 / Filtros F6-F7 + filtro a bolsas externo F8-F9
- Filtri F6-F7 + batteria acqua calda esterna / Filtros F6-F7 + batería de agua caliente

RCA 3000

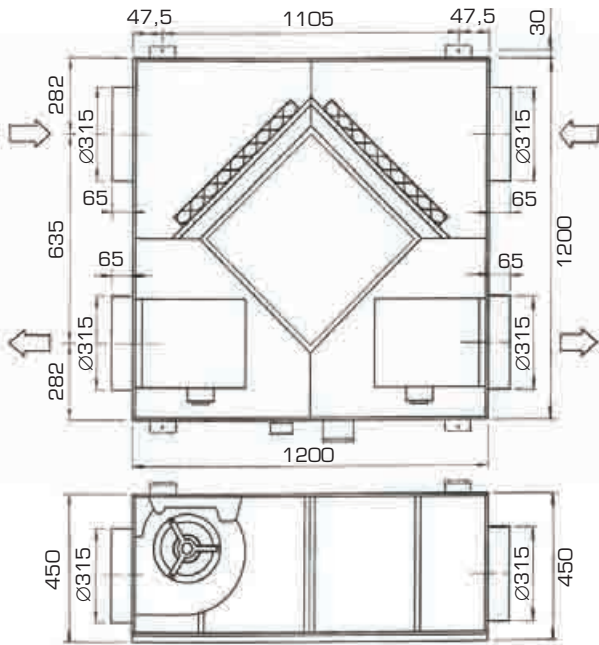

RCA-V 3000

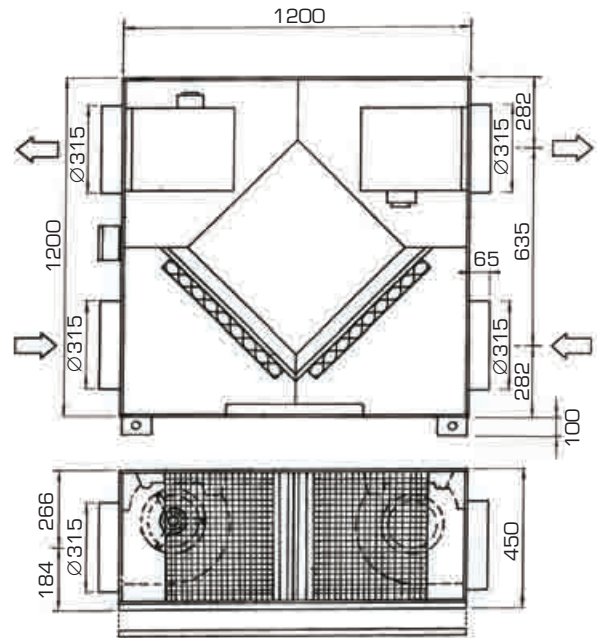

I valori sopraindicati sono stati calcolati secondo la norma europea EN 308.

The above values are calculated in reference to the european norm EN 308.

Los valores indicados arriba se han calculado según la norma europea EN 308.

- Su richiesta pacchi di scambio con maggiore efficienza
- On request Exchanger with higher efficiency
- Bajo demanda recuperadores de placas con mayor eficacia

Portata Aria	Aria Ambiente	Aria Rinnovo	Aria Rinnovo	Aria Trattata	Efficienza	Potenza Recuperatore
Capacity Air	Air Ambiente	Air Rinnovo	Air Rinnovo	Air Trattata	Efficiency	Power Recuperators
Capacidad Aire	Aire Ambiente	Aire Recambio	Aire Recambio	Aire Tratada	Eficiencia	Potencia Recuperador
m³/h	°C	°C	R.H. %	°C	%	KW
3000	20	-5	80	10	60	16
3000	26	34	50	29,8	52	4



[dB] Lp - Livelli di pressione sonora dB(A) - ISO 3741 - rilevati alla distanza di mt. 2 in campo libero dal centro dei recuperatori con canalizzazioni in immissione/estrazione

Modello / Type / Modelo	Volt / Hz / PH	W	Ampere	Regolatore / Speed Controller / Regulador
RCA / RCA-V 3000	230 / 50 / 1	2 x 550	2 x 4,20	1 x RMD 10
Filtri / Filters / Filtros acrílicos		Peso / Weight / Peso		Imballo Scatola / Box Packing / Embalaje Caja
F6	N° 2 FO - 500 x 400 x 48	140 kg		mm. 500 x 1350 x H.1500

Filtri acrilici / Filters / Filtros acrílicos F7 - F8 (OPTIONAL)

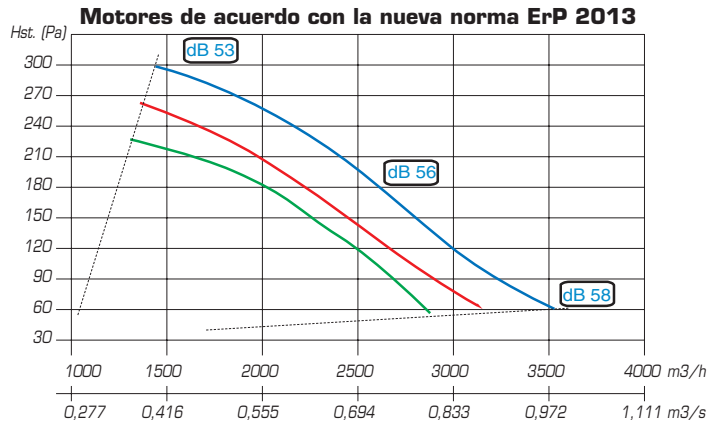

- Filtri interni F6-F7 / Inside Filter class F6-F7 / Filtros internos F6-F7
- Filtri F6-F7 + Filtro tasche esterno F8-F9 / Filtros F6-F7 + filtro a bolsas externo F8-F9
- Filtri F6-F7 + batteria acqua calda esterna / Filtros F6-F7 + batería de agua caliente

RCA 3500

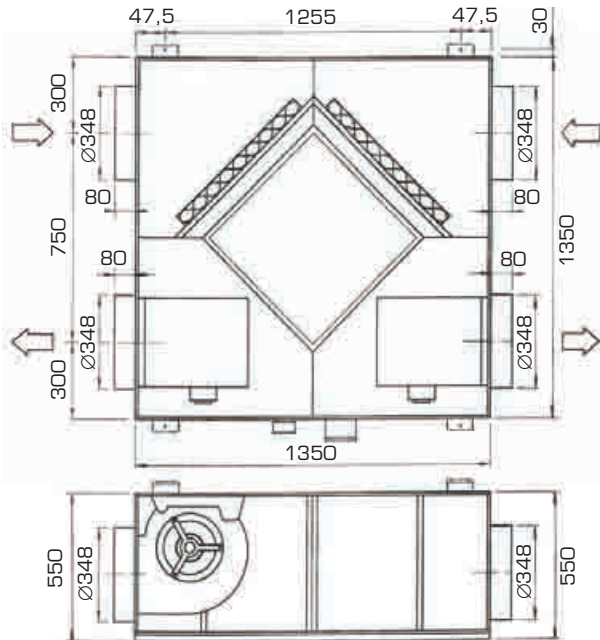

RCA-V 3500

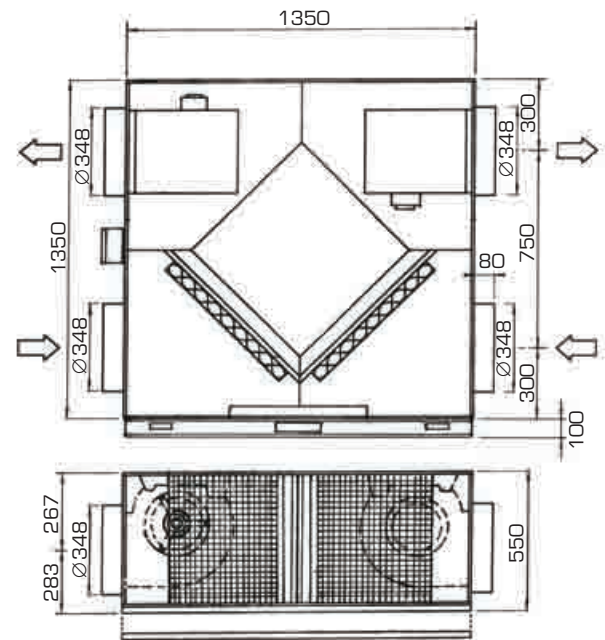

I valori sopraindicati sono stati calcolati secondo la norma europea EN 308.

The above values are calculated in reference to the european norm EN 308.

Los valores indicados arriba se han calculado según la norma europea EN 308.

- Su richiesta pacchi di scambio con maggiore efficienza
- On request Exchanger with higher efficiency
- Bajo demanda recuperadores de placas con mayor eficacia

Portata Aria	Aria Ambiente	Aria Rinnovo	Aria Rinnovo	Aria Trattata	Efficienza	Potenza Recuperatore
Capacity Air	Air Ambiente	Air Rinnovo	Air Rinnovo	Air Trattata	Efficiency	Power Recuperators
Capacidad Aire	Aire Ambiente	Aire Recambio	Aire Recambio	Aire Tratada	Eficiencia	Potencia Recuperador
m³/h	°C	°C	R.H. %	°C	%	KW
3500	20	-5	80	8,4	53	17
3500	26	34	50	30,2	47	4,2



[dB] Lp - Livelli di pressione sonora dB(A) - ISO 3741 - rilevati alla distanza di mt. 2 in campo libero dal centro dei recuperatori con canalizzazioni in immissione/estrazione

Modello / Type / Modelo	Volt / Hz / PH	W	Ampere	Regolatore / Speed Controller / Regulador
RCA / RCA-V 3500	230 / 50 / 1	2 x 550	2 x 6,70	2 x RMD 10
Filtri / Filters / Filtros acrílicos		Peso / Weight / Peso		Imballo Scatola / Box Packing / Embalaje Caja
F6 N° 2 FO - 625 x 500 x 48		160 kg		mm. 600 x 1550 x H.1600

Filtri acrilici / Filters / Filtros acrílicos F7 - F8 (OPTIONAL)



Motore di accordo con la nuova norma ErP 2013

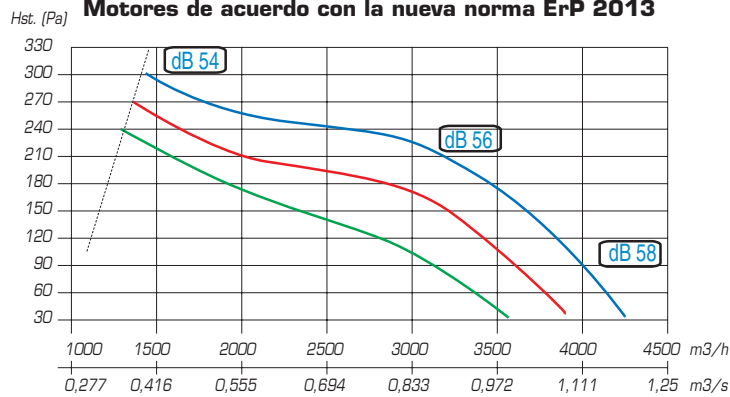

- Filtri interni F6-F7 / Inside Filter class F6-F7 / Filtros internos F6-F7
- Filtri F6-F7 + Filtro tasche esterno F8-F9 / Filtros F6-F7 + filtro a bolsas esterno F8-F9
- Filtri F6-F7 + batteria acqua calda esterna / Filtros F6-F7 + batería de agua caliente

RCA 4200

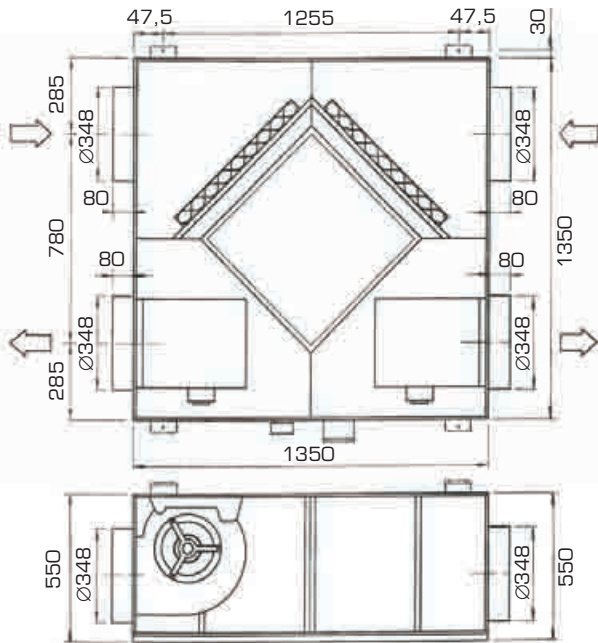

RCA-V 4200

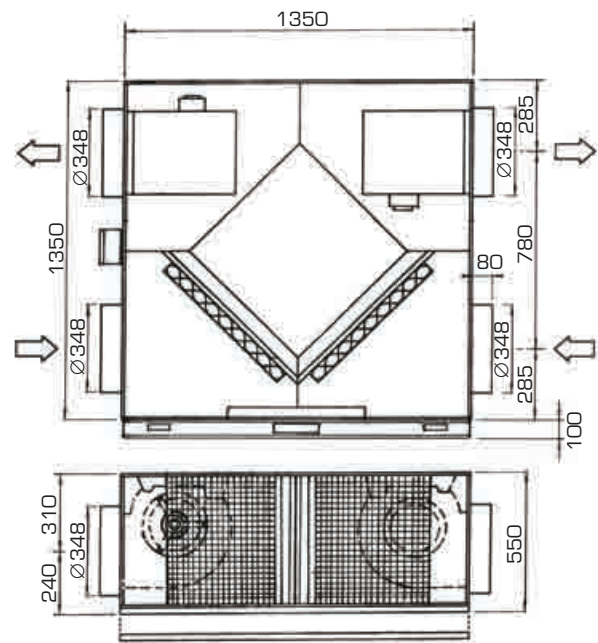

I valori sopraindicati sono stati calcolati secondo la norma europea EN 308.

The above values are calculated in reference to the european norm EN 308.

Los valores indicados arriba se han calculado según la norma europea EN 308.

- Su richiesta pacchi di scambio con maggiore efficienza
- On request Exchanger with higher efficiency
- Bajo demanda recuperadores de placas con mayor eficacia

Portata Aria	Aria Ambiente	Aria Rinnovo	Aria Rinnovo	Aria Trattata	Efficienza	Potenza Recuperatore
Capacity Air	Air Ambiente	Air Rinnovo	Air Rinnovo	Air Trattata	Efficiency	Power Recuperators
Capacidad Aire	Aire Ambiente	Aire Recambio	Aire Recambio	Aire Tratada	Eficiencia	Potencia Recuperador
m³/h	°C	°C	R.H. %	°C	%	KW
4200	20	-5	80	8,2	54	15
4200	26	34	50	30,2	48	3,6



[dB] Lp - Livelli di pressione sonora dB(A) - ISO 3741 - rilevati alla distanza di mt. 2 in campo libero dal centro dei recuperatori con canalizzazioni in immissione/estrazione

Modello / Type / Modelo	Volt / Hz / PH	W	Ampere	Regolatore / Speed Controller / Regulador
RCA / RCA-V 4200	230 / 50 / 1	2 x 600	2 x 6,60	2 x RMD 10
Filtri / Filters / Filtros acrílicos		Peso / Weight / Peso		Imballo Scatola / Box Packing / Embalaje Caja
F6 N° 2 FO - 625 x 500 x 48		165 kg		mm. 600 x 1550 x H.1600

Filtri acrilici / Filters / Filtros acrílicos F7 - F8 (OPTIONAL)

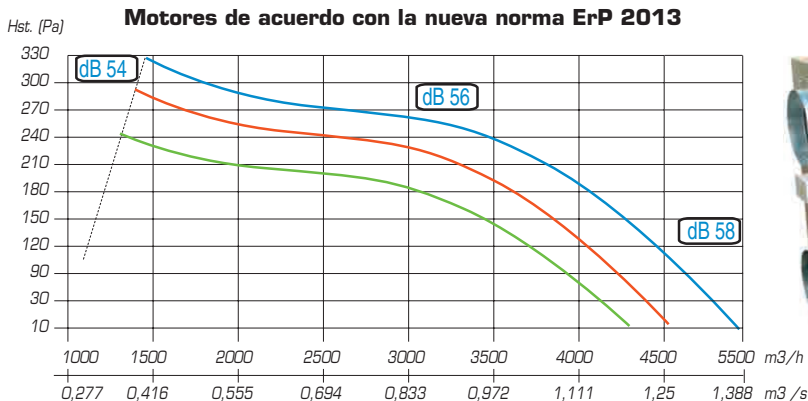

- Filtri interni F6-F7 / Inside Filter class F6-F7 / Filtros internos F6-F7
- Filtri F6-F7 + Filtro tasche esterno F8-F9 / Filtros F6-F7 + filtro a bolsas externo F8-F9
- Filtri F6-F7 + batteria acqua calda esterna / Filtros F6-F7 + batería de agua caliente

RCA 5500 TD

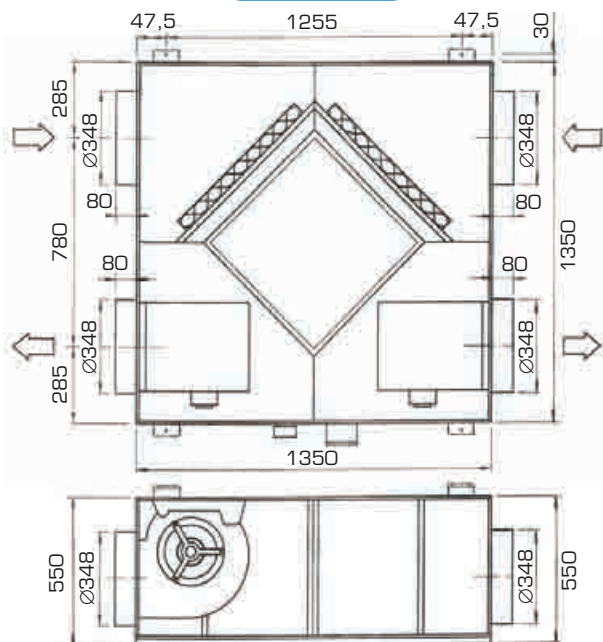

RCA-V 5500 TD

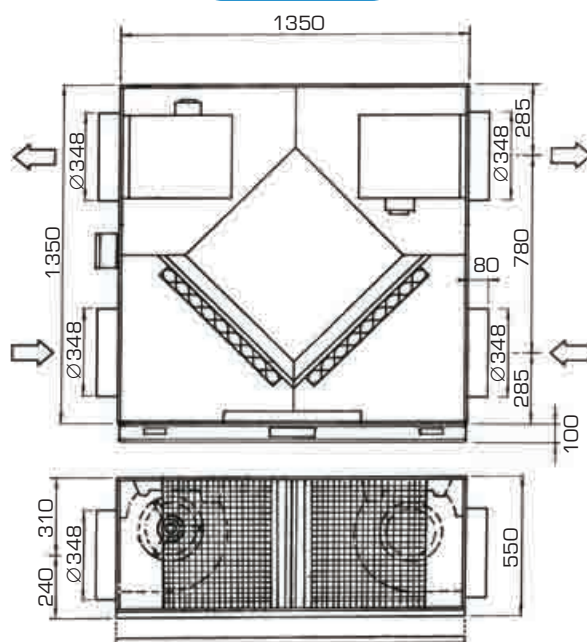

I valori sopraindicati sono stati calcolati secondo la norma europea EN 308.

The above values are calculated in reference to the european norm EN 308.

Los valores indicados arriba se han calculado según la norma europea EN 308.

- Su richiesta pacchi di scambio con maggiore efficienza
- On request Exchanger with higher efficiency
- Bajo demanda recuperadores de placas con mayor eficacia

Portata Aria	Aria Ambiente	Aria Rinnovo	Aria Rinnovo	Aria Trattata	Efficienza	Potenza Recuperatore
Capacity Air	Air Ambiente	Air Rinnovo	Air Rinnovo	Air Trattata	Efficiency	Power Recuperators
Capacidad Aire	Aire Ambiente	Aire Recambio	Aire Recambio	Aire Tratada	Eficiencia	Potencia Recuperador
m³/h	°C	°C	R.H. %	°C	%	KW
5500	20	-5	80	8,1	52	21
5500	26	34	50	30,3	47	5,3



[dB] Lp - Livelli di pressione sonora dB(A) - ISO 3741 - rilevati alla distanza di mt. 2 in campo libero dal centro dei recuperatori con canalizzazioni in immissione/estrazione

Modello / Type / Modelo	Volt / Hz / PH	W	Ampere	Regolatore / Speed Controller / Regulador
RCA / RCA-V 5500 TD	400 / 50 / 3	2 x 550	2 x 2,5	INVERTER
Filtri / Filters / Filtros acrílicos		Peso / Weight / Peso		Imballo Scatola / Box Packing / Embalaje Caja
F6 N° 2 FO - 625 x 500 x 48		165 kg		mm. 600 x 1550 x H.1600

Filtri acrilici / Filters / Filtros acrílicos F7 - F8 (OPTIONAL)

Motori de acuerdo con la nueva norma ErP 2013

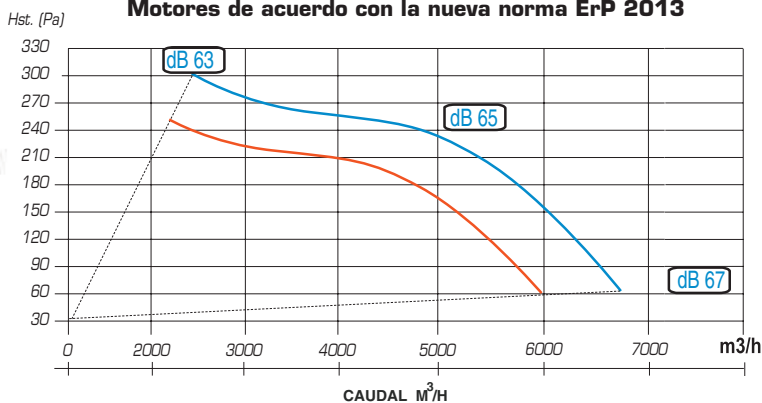

- Filtri interni F6-F7 / Inside Filter class F6-F7 / Filtros internos F6-F7
- Filtri F6-F7 + Filtro tasche esterno F8-F9 / Filtros F6-F7 + filtro a bolsas externo F8-F9



RCA 6500 TD

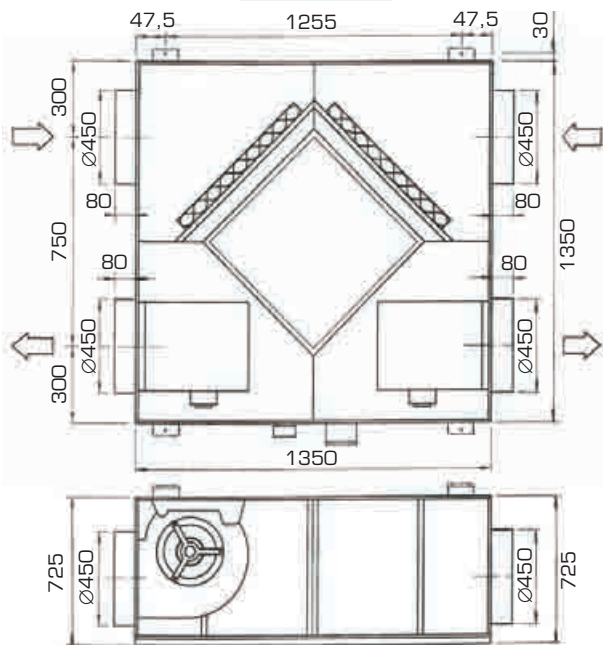

RCA-V 6500 TD

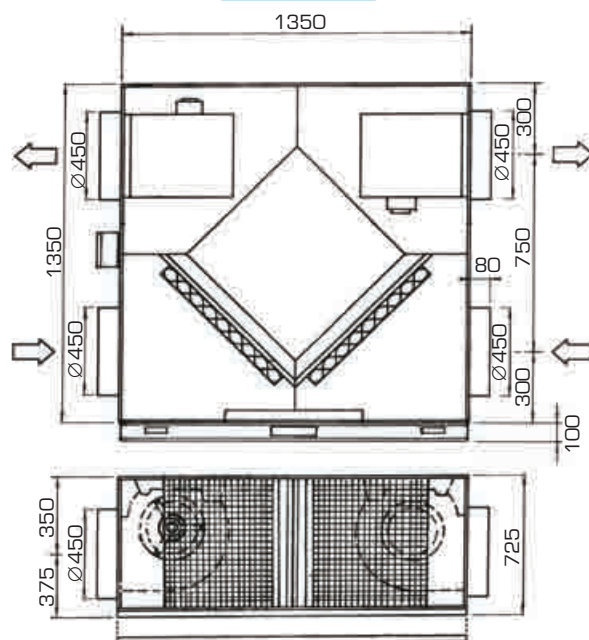

I valori sopraindicati sono stati calcolati secondo la norma europea EN 308.

The above values are calculated in reference to the european norm EN 308.

Los valores indicados arriba se han calculado según la norma europea EN 308.

- Su richiesta pacchi di scambio con maggiore efficienza
- On request Exchanger with higher efficiency
- Bajo demanda recuperadores de placas con mayor eficacia

Portata Aria	Aria Ambiente	Aria Rinnovo	Aria Rinnovo	Aria Trattata	Efficienza	Potenza Recuperatore
Capacity Air	Air Ambiente	Air Rinnovo	Air Rinnovo	Air Trattata	Efficiency	Power Recuperators
Capacidad Aire	Aire Ambiente	Aire Recambio	Aire Recambio	Aire Tratada	Eficiencia	Potencia Recuperador
m³/h	°C	°C	R.H. %	°C	%	KW
6500	20	-5	80	8,2	54	15
6500	26	34	50	30,2	48	3,6



[dB] Lp - Livelli di pressione sonora dB(A) - ISO 3741 - rilevati alla distanza di mt. 2 in campo libero dal centro dei recuperatori con canalizzazioni in immissione/estrazione

Modello / Type / Modelo	Volt / Hz / PH	W	Ampere	Regolatore / Speed Controller / Regulador
RCA / RCA-V 6500 TD P6T	400 / 50 / 3	2 x 1100	2 x 3,6	INVERTER
Filtri / Filters / Filtros acrílicos		Peso / Weight / Peso		Imballo Scatola / Box Packing / Embalaje Caja
F6 N° 2 FO - 625 x 700 x 48		193 kg		

Filtri acrilici / Filters / Filtros acrílicos F7 - F8 (OPTIONAL)

Motori de acuerdo con la nueva norma ErP 2013

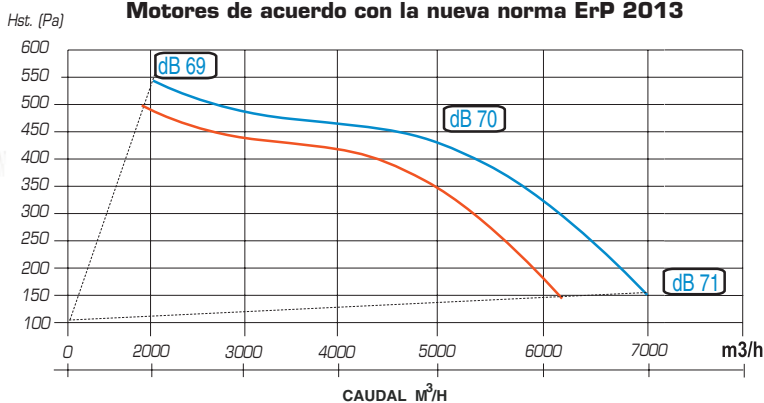

- Filtri interni F6-F7 / Inside Filter class F6-F7 / Filtros internos F6-F7
- Filtri F6-F7 + Filtro tasche esterno F8-F9 / Filtros F6-F7 + filtro a bolsas externo F8-F9



RCA 7000 TD

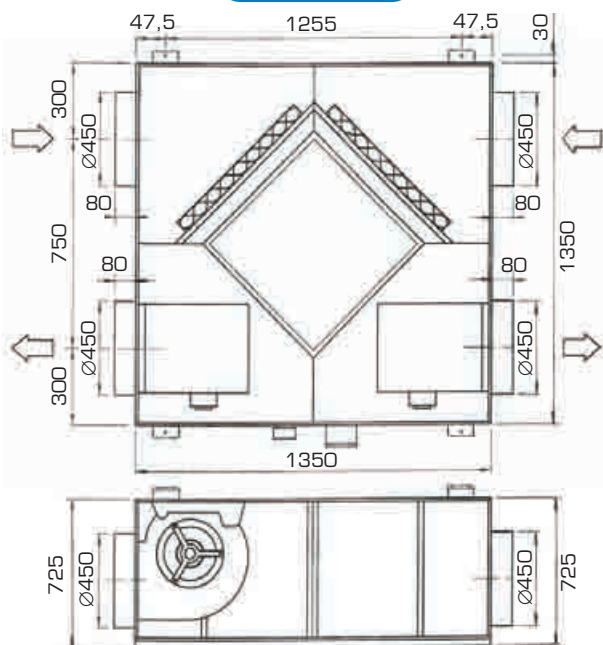

RCA-V 7000 TD

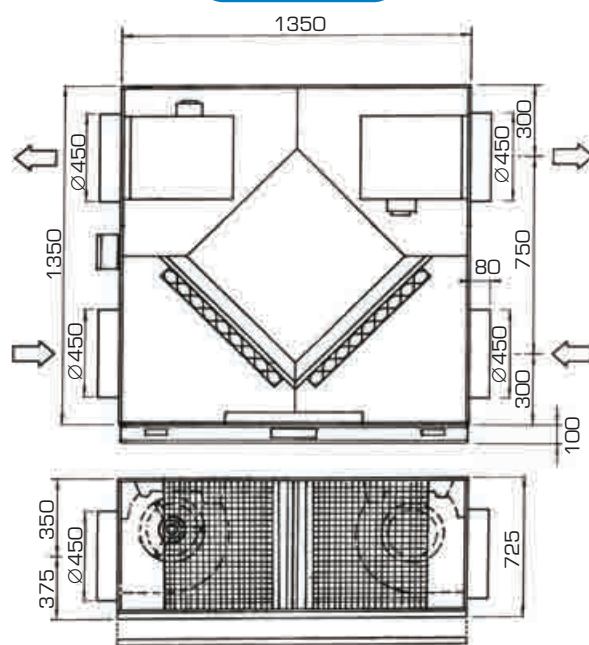

I valori sopraindicati sono stati calcolati secondo la norma europea EN 308.

The above values are calculated in reference to the european norm EN 308.

Los valores indicados arriba se han calculado según la norma europea EN 308.

- Su richiesta pacchi di scambio con maggiore efficienza
- On request Exchanger with higher efficiency
- Bajo demanda recuperadores de placas con mayor eficacia

Portata Aria	Aria Ambiente	Aria Rinnovo	Aria Rinnovo	Aria Trattata	Efficienza	Potenza Recuperatore
Capacity Air	Air Ambiente	Air Rinnovo	Air Rinnovo	Air Trattata	Efficiency	Power Recuperators
Capacidad Aire	Aire Ambiente	Aire Recambio	Aire Recambio	Aire Tratada	Eficiencia	Potencia Recuperador
m³/h	°C	°C	R.H. %	°C	%	KW
7000	20	-5	80	8,2	54	15
7000	26	34	50	30,2	48	3,6



[dB] Lp - Livelli di pressione sonora dB(A) - ISO 3741 - rilevati alla distanza di mt. 2 in campo libero dal centro dei recuperatori con canalizzazioni in immissione/estrazione

Modello / Type / Modelo	Volt / Hz / PH	W	Ampere	Regolatore / Speed Controller / Regulador
RCA / RCA-V 7000 TD P4T	400 / 50 / 3	2 x 1500	2 x 5	INVERTER
Filtri / Filters / Filtros acrílicos		Peso / Weight / Peso		Imballo Scatola / Box Packing / Embalaje Caja
F6 N° 2 FO - 625 x 700 x 48		193 kg		

Filtri acrílicos / Filters / Filtros acrílicos F7 - F8 (OPTIONAL)